

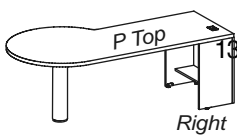
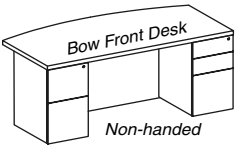
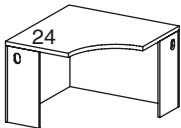
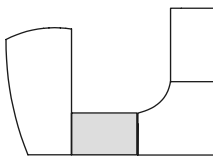
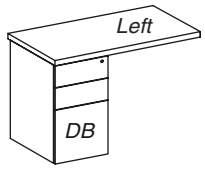
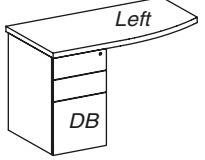
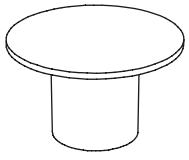
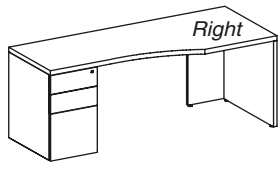
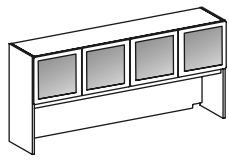

OCTOBER 2007

S E R I E S 5 0
P R I C E L I S T

MAGNA
D E S I G N

Series 50 Table of contents

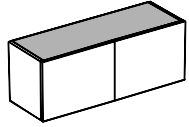
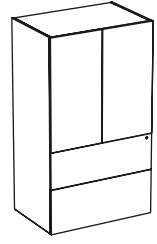
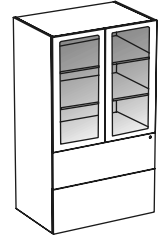
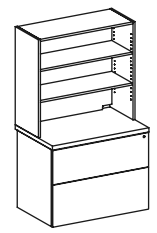
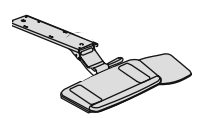
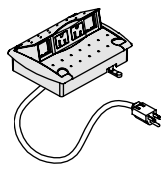
	Page		Page		Page
Pricing and Delivery	4		13		14
Warranty	4				15
Terms and Conditions	5				16
Specifications	6				17
Finishes	6				18
Edge profiles	6				19
Pulls	6				20
Magna Now shipping program	6				24
Overview of top shapes and grommet locations	8				25
Orientation: LEFT and RIGHT	9				26
Grain direction on worktops	9				28
Shaped modesty panels	10				29
Configurations S50-101 through S50-109	11				33
Desks	13				35
Corner units	15				35
Corner extension desks	15				
Bridges	16				
Returns	17				
Desk extensions	19				
Round office tables	19				
Credenzas	20				
Metal privacy screens	22				
Hutches	23				
Hutch tackboards	25				
Shaped valance on hutch	25				
Paper Storage Shelf for hutch	25				
Desk top organizer	25				
Overheads, wall mounted	26				
Overhead tackboards	27				
Tasklights	27				
Towers	28				
Lateral Files, 2, 3 or 4 drawers	32				
Lateral File lower with hutch	33				
Bookcases	34				
Accessories	35				
Product index	36				

Pricing and Delivery information

PRICES:

Prices are subject to change without notice and the price list with the later date supersedes all previous price lists.

Prices do not include charges for cartooning, crating, installation, or inside delivery.

Cartoning or crating charges will be added to orders weighing under 250 lb.

DELIVERY:

All prices include delivery outside the Zone 1 region.

Zone 1 includes Washington, Oregon, Alaska, Hawaii, and British Columbia. Prices in Zone 1 reflect Factory Will Call. Zone 1 dealer discounts are adjusted accordingly.

A freight surcharge will be added to Zone 2 orders totaling less than \$10,000 LIST. The freight surcharge will be 10% of NET invoice total.

A Fuel Surcharge will be added to all orders that include delivery. Please see our website [http:// www.magnadesig.com](http://www.magnadesig.com) for current details.

Standard delivery will be made on a dock-to-dock basis or to a sidewalk. Should you have special requirements such as inside delivery or prior notification please contact Magna Design's traffic department. Special delivery requirements will be handled on an as-available basis and will likely result in additional charges.

All Shipments are FOB Magna Plant, Lynnwood, Washington.

MagnaCad



The MagnaCad graphic and specification package includes the complete Series 50 symbol library for 2D layout drawings and 3D isometric illustrations. The Series 50 symbol library is linked directly to specification and pricing information.

Access Series 50 components by model or description.

Both left and right orientations are provided as needed for each model.

Series 50 product graphic and specification packages are available for use with 20-20 GIZA software, Data One's Design Express software and Project Matrix's Project Spec software. Software such as 20-20 GIZA, Design Express or Project Spec may be purchased directly from the software provider. Magna provides just the graphic and specification information for our product lines that can be used in these third party software products.

LIFETIME limited warranty

MAGNA DESIGN warrants that its products are free from defects in design, material, and workmanship under normal use and with proper care and maintenance. This warranty will remain in effect for the following period of time, commencing with the date of purchase from MAGNA DESIGN but only so long as the original purchaser continues to own the product:

- WoodPlus2 finishes on products purchased January 2002 or later - **LIFETIME**
- Drawer slides - **LIFETIME**
- LIFETIME for ALL PRODUCT and COMPONENTS, not listed below
- Healthcare products - **ten (10) years**
- Electrical components and functional mechanisms, like keyboard trays - **five (5) years**
- Wood finishes - **three (3) years.**

During the term of this Warranty, MAGNA DESIGN will repair or replace with the same or comparable product or part without charge any product or part that malfunctions or fails to conform to this Warranty. THIS REMEDY OF REPAIR OR REPLACEMENT IS PURCHASER'S SOLE AND EXCLUSIVE REMEDY WITH REGARD TO ANY PRODUCT DEFECT.

This Warranty does not apply to:

- Any damage caused during shipment.
- Any product installed or used other than in accordance with MAGNA DESIGN guidelines.
- Any product that has been repaired, altered, or modified by any person other than MAGNA DESIGN.
- Any attachment added to a product.
- Any fabric or upholstery material.
- Any part or material provided by Purchaser.
- Any damage caused by misuse, abuse, or negligence on the part of Purchaser or any third party.

THERE ARE NO OTHER WARRANTIES, EITHER EXPRESSED OR IMPLIED, INCLUDING ANY WARRANTY OF MERCHANTABILITY OR OF FITNESS FOR A PARTICULAR PURPOSE. UNDER NO CIRCUMSTANCES WILL MAGNA DESIGN BE LIABLE FOR ANY CONSEQUENTIAL OR INCIDENTAL DAMAGES ARISING FROM ANY PRODUCT DEFECT.

This warranty is in effect for products shipped on or after May 1, 1998.

Terms and Conditions

QUOTATIONS:

Price quotations on non-catalog or special orders will not be valid after thirty (30) days without written approval from Magna Design, Inc.

CREDIT TERMS

Net thirty (30) days after invoice date upon credit approval.

ORDERING :

When ordering, please include complete identification and description of the product being ordered using Magna Design specifications and terminology. All orders must be in writing.

TELEPHONE ORDERS:

All telephone orders must be confirmed with a written purchase order.

ACKNOWLEDGMENTS:

All orders when accepted will be acknowledged by mail indicating the terms and conditions by which the order was accepted and a description of the items being ordered. Orders will be completed and shipped in accordance with the information on the acknowledgment. If the acknowledged information is incorrect we must receive written instruction to change.

CHANGE ORDERS:

Order entry will take place upon receipt of an ENTERABLE purchase order from an authorized Magna Design dealer.

Once the order has been entered, no changes are allowed on MAGNA NOW! orders.

For orders not on the MAGNA NOW! shipping program, order changes will be subject to a minimum \$25 processing fee. Actual change order charges may be higher depending on the status of the job at the time a change is made.

CANCELLATIONS:

A 15% minimum restocking charge will be applied on cancellations of standard products.

Cancellations will not be accepted on special or custom products.

RETURNED GOODS:

Returned merchandise will not be accepted for return without twenty (20) days prior written notice and written Returned Goods Authorization (RGA) from Magna. Returned goods will be subject to a minimum 15% restocking and refurbishing charge in addition to shipping costs. (See Warranty policy for defective goods.)

LEAD TIMES:

To current accounts with approved credit, Magna FLEX *enterable* orders will be made available (in standard finishes) within 4 to 6 weeks. All orders are subject to current inventories. Leadtimes may vary according to factory volume.

To current accounts with approved credit, Magna NOW! *enterable* orders in standard finishes will be made available 10 *working days* after receipt of *enterable* order. *Working day* = Monday through Friday except factory holidays.

Day 1 (of 10) starts upon receipt of *enterable* order before 2:00 PM Pacific Time.

Will Call orders will be ready at 2:00 PM of Day 10. Leadtimes may vary according to factory volume.

DELIVERY:

Orders will be delivered in accordance with the delivery dates indicated on the order acknowledgment and partial shipments may be made unless the order instructions indicate that an order must be shipped complete.

SHIPPING:

We reserve the right to use our own discretion in selecting routes and freight carriers. We will attempt to meet any special routing requirements that you may have but assume no liability for damages or costs incurred by our inability to do so.

STORAGE:

Storage charges will be charged on orders not accepted or picked up within five (5) days of acknowledged delivery dates unless we are notified thirty (30) days in advance. Storage will be charged at the rate of 2% for the first fifteen (15) days delay and 3% for each fifteen (15) day period thereafter.

FREIGHT CLAIMS:

Before signing a delivery receipt, make certain that goods are inspected for possible damage. If there is visual damage, record the extent of the damage on all copies of the bill of lading before signing. If there is no visual damage to goods that are cartoned or crated, we strongly suggest that the merchandise be unpacked and inspected immediately. If damages are discovered, save the packaging and contact the carrier immediately for inspection. Claims for damages should be filed with the delivering carrier and payment for the goods may not be withheld pending settlement of the carrier damage claims. Magna assumes no liability for freight damage or the workmanship or cost of repairs made by others without prior written authorization. SPECIFICATIONS:

All published dimensions and weights are approximate and we assume no liability for errors or inaccuracies in product literature. We reserve the right to modify or change product design and/or delete product models without prior notice.

FINISHES:

We take great care in matching color and texture of materials in our product. However, it is impossible to guarantee exact matching in all cases.

Series 50 Specifications

The Series 50 group is designed to offer a contemporary design, shipped ready to assemble, and provides a wide variety of configurations

SPECIFICATION HIGHLIGHTS

All exposed laminate surfaces shall be Magna WoodPlus laminate. Standard finishes shall include WoodPlus wood grain patterns as described in the finishes section. Pedestals, lateral files, hutches, overheads and end support panels are also available in ColorPlus laminates.

Edge Bands

Desk tops are 1.5" thick and are banded with 3mm PVC or 3mm hardwood. Drawer fronts and doors are banded with matching .020 PVC.

Tops and top edges

All Series 50 tops are 1.5" thick. The three ply balanced construction consists of a 45 LB industrial board core surfaced with WoodPlus laminate and a balancing backer sheet. Worktop edges may be finished with smooth, reeded or neoclassic edge profile, 3mm PVC or hardwood with radius on top and bottom on the worktops only.

Pedestals

In a component layout, pedestal configuration is specified as DB Box Box File with Lock and DF File File with Lock. When ordered as a component part, pedestals are available in: DB Box Box File with Lock or DF File File with Lock.

Support Panels, Half Cylinders, Hutch Ends and Shelves

All support panels, hutch ends and hutch shelves are 3/4" thick, three ply balanced construction. End panels, half cylinders and hutch ends are constructed with vertical grain patterns. All Series 50 end panels are supplied with support brackets.

Front, Modesty and Back Panels

All drawer fronts, pedestal and cabinet case sides and back, modesty panels and hutch backs are 3/4" thick, three ply balanced construction. Modesty panels are available with horizontal grain patterns which are parallel to the work surface or with vertical (up to 60") grain patterns. Desk and credenza modesty panels are typically constructed with horizontal grain.

Drawer fronts, pedestal and cabinet sides and backs are constructed with vertical grain patterns.

Drawers

All drawers are constructed as a five sided box with separate attached drawer faces. This technique ensures superior structural integrity and easy drawer front replacement. Standard drawers are of miter fold construction with a black vinyl finish and matching high density hardboard bottom. Applied drawer pull is through fastened for maximum strength.

Filing Capabilities

All file drawers are provided with file holders configured for letter front to back and legal side to side filing. Lateral file drawers are provided with file holders configured for side to side filing. Hardware is finished in a matte black.

Drawer Suspension

Pedestal drawers utilize full extension ball bearing, 100 LB rated slides.

Lateral File drawers utilize full extension progressive action ball bearing, 150 LB slides. Lateral Files are equipped with an anti-tilt device for safety.

Locks

Locks are included on all drawer pedestals and lateral files. Combo-A and Combo-B include lock for the lateral file and file drawers. The two box drawers in Combo-A and Combo-B do not lock.

Removable lock cylinders provide for keying alike or re-keying in the field. An optional Cylinder change tool is available to re-key locks, please contact Customer Service.

Hutches

Series 50 hutches are available as open or full overly WoodPlus or Aluminum framed Glass hinged doors, all with valance. WoodPlus hinged doors have vertical grain. Door Pulls are optional; hinged Door pull is screw fastened for maximum strength. Worklights can be mounted below fixed shelf for additional lighting.

Hutches can only be installed on worksurfaces with full depth support, i.e. 24" deep tops and support components or 30" deep tops and support components.

Adjustable Glides

All free standing components are equipped with threaded stem adjustable glides. Glides are set in threaded inserts fitted in a PVC edge band for structural integrity.

Wire Management

Grommets are included on corner tops. Finish is satin black. Grommets are located so that Rectangular, Corner and Radius End tops are non-handed. P tops are handed with or without a grommet. Bow front tops are handed when a grommet is added.

Worklight

All worklights are UL labeled and have a built in diffuser. Finish is black.

Finishes

Series 50 components are available in WoodPlus finishes with a matching WPE WoodPlus wood grained PVC edge. Pedestals, cabinets and end support panels are also available in ColorPlus laminates.

Magna WoodPlus laminate finish consists of a unique combination of wood products and resins thermofused under high temperature and pressure into a single, wood grained or solid color structural panel. Work surfaces are WoodPlus high pressure. Panel edges are finished in matching PVC.

Cleaning and Care

WoodPlus / ColorPlus may be cleaned with mild cleaning agents that contain no abrasives, bleach or bleach substitutes. Under no circumstances can acetone or polish remover be used to clean any of the surfaces. Using it will void the warranty on the product and can do considerable damage to the surface.

Specifications are subject to change without notice.

Series 50 specifications, finishes, edge profiles, pulls, base styles, warranty

Specification Highlights

The Series 50 product line offers a clean, crisp design and effective use of space. Tops are 1 1/2" thick with your choice of 3mm woodgrained PVC or 3mm wood edge and various edge profiles.

Upcharge of \$100 List per top for 3mm wood edge, any edge profile.

New architectural top shapes along with the lighter scale of 3/4" vertical construction with full overlay doors and drawer fronts adds a new sense of sophistication and a crisp, clean look.

List Pricing shown assumes the drawer face or doors match the finish of the case. All verticals, doors, drawer fronts, shelves use a matching 018 PVC edge. Please contact customer service for the upcharge when specifying contrasting faces on any Series 50 product. All drawer storage comes with locks. All doors are available with optional locks.

Finishes







Please specify each workstation using one finish per station. You may choose to use a second finish for the worksurfaces only. The Series 50 product line offers the following finishes:

WP04 Solar Oak	WP33 Blossom Cherry ①④	WP48 Sipping Seattle Java ⑤	WP75 Chestnut ①
WP05 Rift Oak ①	WP35 Golden Cherry ①②	WP61 Pear	WP81 Fusion Maple
WP15 Midnight ①②⑤	WP37 Mocha Cherry ①②	WP67 Chocolate Pear ①②	CP76 Espresso ③
WP23 Cordovan	WP41 Natural Maple	WP71 Dark Cherry	CP88 Black ⑤
WP31 Medium Cherry	WP45 Anigre	WP73 Cognac	CP98 Slate ⑤

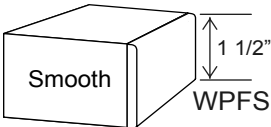
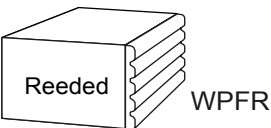
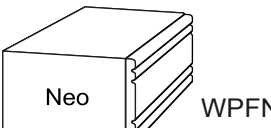
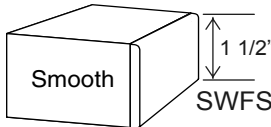
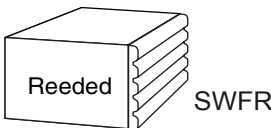
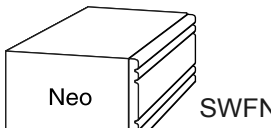
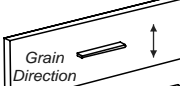
- ① upcharge of \$600 List per order for these finishes
- ② there is no matching WPE PVC edge for worksurfaces in these finishes, please either choose another WPE edge or specify a matching worksurface STD wood edge and add \$100 list per worksurface
- ③ available only for vertical surfaces
- ④ Hi-Lustre is the worksurface texture, all other surfaces have a suede texture.
- ⑤ Hi-Brite is the worksurface texture, all other surfaces have a suede texture.

Please visit our website at www.magnadesign.com or call Customer Service at 800.233.2304 for the latest finish information.

Edge profiles and pulls

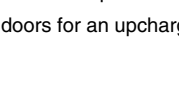
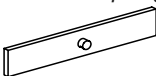
<p>Edge profiles: for 3mm WoodPlus PVC edges</p>  <p>Smooth WPFS</p>  <p>Reeded WPFR</p>  <p>Neo WPFN</p>	<p>Edge profiles: for 3mm Standard wood edges</p>  <p>Smooth SWFS</p>  <p>Reeded SWFR</p>  <p>Neo SWFN</p>	<p>Pull Choices:</p>  <p>#10 Black Chrome</p>  <p>#12 Black</p>  <p>#13 Satin Chrome</p>  <p>#14 Black</p>  <p>#15 Satin Chrome ADA compliant</p>  <p>#18 Black</p>  <p>#19 Satin Chrome ADA compliant</p> <p>Knob Pulls: for Desk Top Organizer Drawers only</p>  <p>#09 Black</p> <p>#10 Black Chrome</p> <p>#11 Satin Chrome</p>
---	--	--

All drawers and doors below worksurface height, include a pull. Glass doors are not available with either a pull or lock. Other doors above worksurface level do not require a pull, optional pulls are available for these doors for an upcharge

MAGNA NOW! - 10 business day shipping program

The MAGNA NOW! - 10 business day shipping program includes all Series 50 product except for

- product with glass doors, e.g. hutches, storage towers or overheads when glass doors are included
- product ordered with a STD Standard wood edge on the worksurfaces.

You must clearly mark your order as MAGNA NOW!

For large orders, please check with Customer Service 800.233.2304 as factory volume may affect leadtime.

Series 50 Overview & Optional Grommet Locations

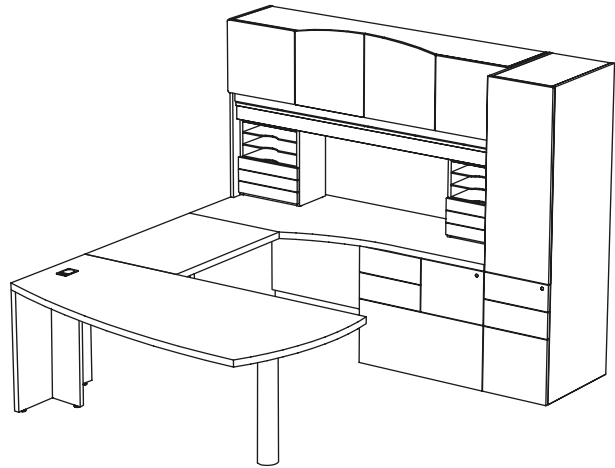
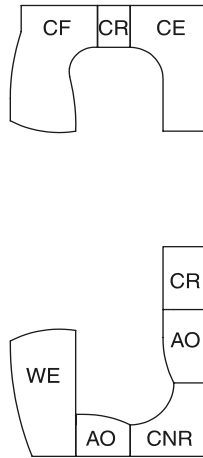
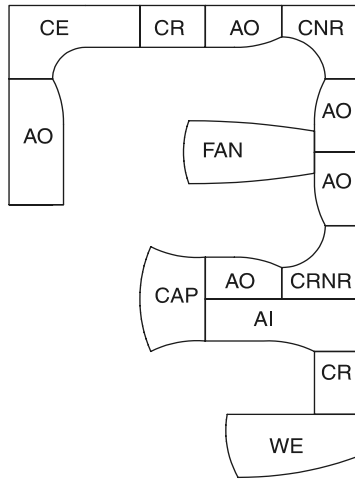

DESKS	BOW FRONT	BOW END	BOW END	RECTANGLE	
	WEDGE	WEDGE	P TOP	P TOP	
CREDENZAS	ARCH IN	ARCH IN	RECTANGLE		
CORNERS, CONFERRING TOPS	CORNER	CORNER	CORNER EXTENSION	CORNER EXTENSION	CONFERRING
<i>Corner grain direction varies, see pg. 8</i>					
DESK EXTENSIONS	WEDGE	WEDGE	FAN	BOW END	CAP
RETURNS, BRIDGES	RECTANGLE	ARCH OUT	RECTANGLE	ARCH OUT	
<i>S2S grain direction is Side to Side</i>			<i>F2B grain direction is Front to Back</i>		

Standard locations for optional Grommets (GR) shown.
Arrows indicate grain direction.

Series 50 LEFT - RIGHT layout and GRAIN direction

Worksurface Left and Right designation in SERIES 50

When seated at a desk,
 When the bridge or return is to the user's left, it is specified a LEFT,
 When the bridge or return is to the user's right, it is specified a RIGHT.

AO shaped Bridge top is the exception to the above rule.
 The AO (curved front edge) Bridge top is either to the LEFT or RIGHT of the corner top it is connected to.

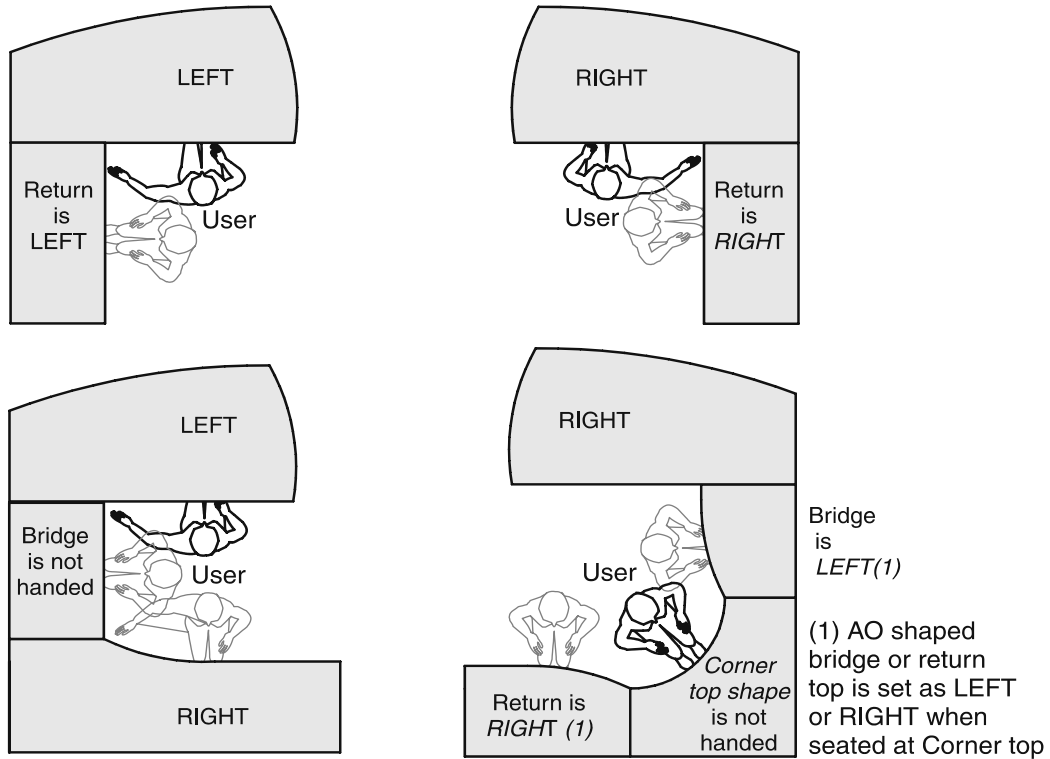

Grain direction in SERIES 50

Corners are not handed by shape, but by woodgrain direction:
 grain LEFT - in line with grain of the top to the LEFT of corner,
 grain RIGHT - in line with grain of top to RIGHT of corner,
 If no grain direction is specified on a corner top, grain will run S2S Side to Side.

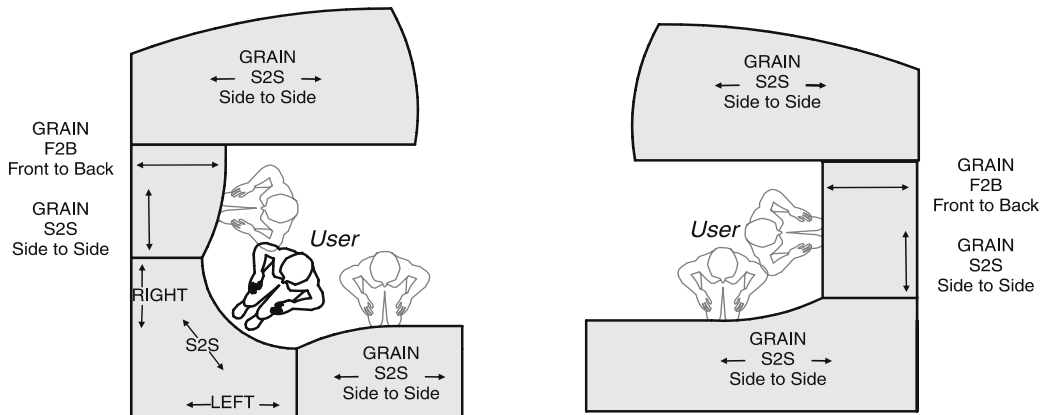

Series 50 shaped modesty panels

MPSC
Shaped center
(as if it had two peds)

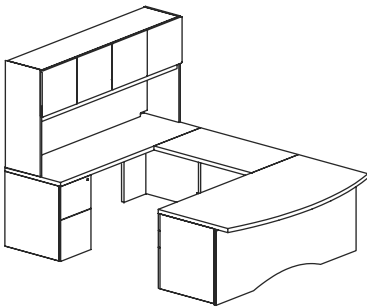
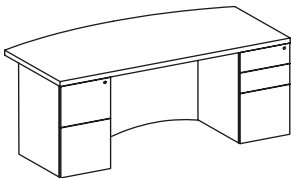
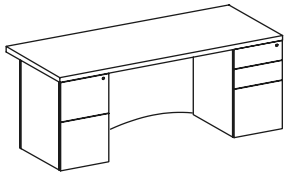
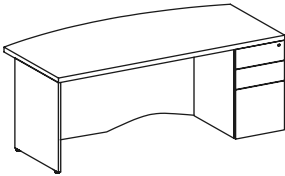
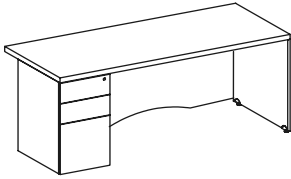

MPSF
Shaped full length

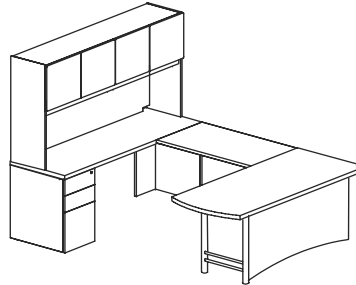
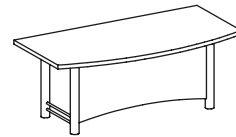
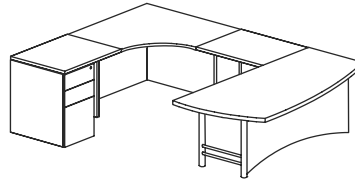

A freestanding desk
with a pedestal or cabinet
and an HLEG
does NOT have the option of
a rectangular or a
shaped modesty panel

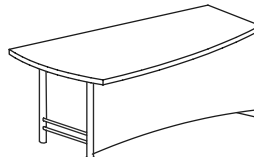

Because of the height of the
modesty panel with an HLEG,
the bottom of the pedestal or
cabinet back would be exposed

Series 50 Configurations

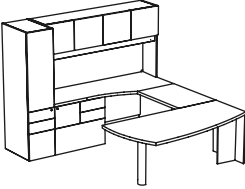
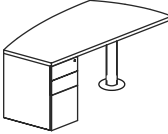
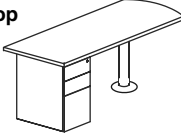
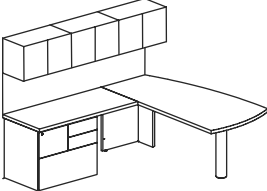
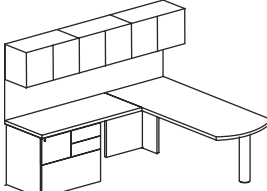
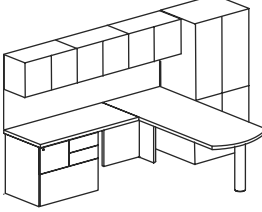
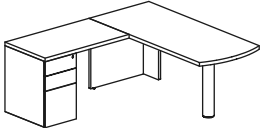
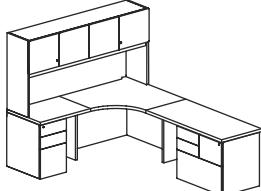
	<i>Model</i>	<i>Qty</i>	<i>WPE Edge</i>	
			<i>List</i>	<i>Ext</i>
S50-100 	S50-D-3672-WE-CB-L	1	1,090	1,090
	S50-B-2436-CR-F2B	1	296	296
	S50-CR-3072-AI-BC-R	1	2,007	2,007
	S50-H-72-35-HD	1	1,030	1,030
	S50-ST-1665-24-UHD-DB-L	1	1,427	1,427
	S50-FPI-72-35 (made in 2 pieces)	1	254	254
	WL48	1	115	115
				6,219
S50-101 WEDGE top 	S50-D-3672-WE-DB-CB-L	1	1,723	1,723
	Column base plate has been added			
S50-101 BOW END top 	S50-D-3072-BE-DB-C-L	1	1,548	1,548
	Column base plate has been added			
S50-102 WEDGE top 	S50-D-3672-WE-CB-L	1	1,090	1,090
	S50-R-2466-CR-BC-L-S2S	1	1,477	1,477
	S50-HDT30-WK	1	622	622
	S50-HDT60-WK	1	948	948
	FPW-1890 (made in 2 pieces)	1	286	286
	WL48	1	115	115
S50-102 BOW END top 	S50-D-3072-BE-CB-L	1	927	927
	S50-R-2460-CR-BC-L-F2B	1	1,457	1,457
	S50-HDT30-WK	1	622	622
	S50-HDT60-WK	1	948	948
	FPW-1890 (made in 2 pieces)	1	286	286
	WL48	1	115	115
S50-102 BOW END top, TOWER 	S50-D-3072-BE-CB-L	1	927	927
	S50-R-2460-CR-BC-L-F2B	1	1,457	1,457
	S50-ST-3065-24-UHD-LHD	1	1,399	1,399
	S50-HDT30-WK	1	622	622
	S50-HDT60-WK	1	948	948
	FPW-1890 (made in 2 pieces)	1	286	286
	WL48	1	115	115
				5,754
S50-103 	S50-D-3072-BE-CB-L	1	927	927
	S50-R-2442-CR-DB-L-F2B	1	1,072	1,072
S50-104 	S50-CNR-4224-RIGHT	1	1,452	1,452
	S50-R-2430-CR-DB-L-F2B	1	1,044	1,044
	S50-R-2454-CR-AC-R-S2S	1	1,442	1,442
	S50-H-72-35-HD	1	1,030	1,030
	S50-FPI-72-35 (made in 2 pieces)	1	254	254
	WL48	1	115	115
				5,337

On these configurations, we included tasklights (WL36 or WL48) and fabric tackboards with all hutches and overheads
All Series 50 configurations shown here when ordered with WPE WoodPlus edge are available on Magna NOW!

Series 50 Configurations

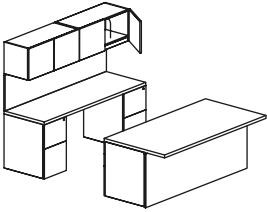
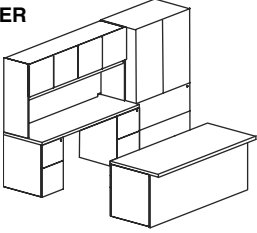
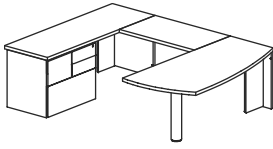
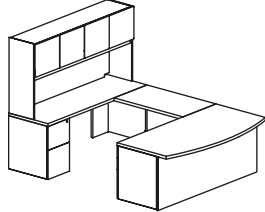
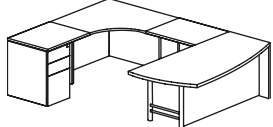
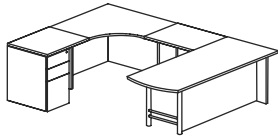
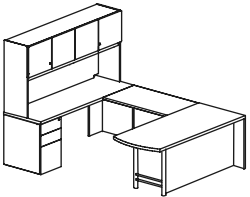
	<i>WPE Edge</i>			
		<i>List</i>	<i>Ext</i>	
S50-105 	S50-D-3672-CR-DF-DF-MP	1	2,170	2,170
	S50-CR-2472-CR-DF-DF	1	1,903	1,903
	S50-HDT36-WK	2	676	1,352
	FPW-1872 (made in 2 pieces)	1	254	254
	WL36	2	99	198
				5,877
S50-105 with HUTCH and TOWER 	S50-D-3672-CR-DB-DF-MP	1	2,170	2,170
	S50-CR-2472-CR-DF-DF	1	1,903	1,903
	S50-H-72-35-HD	1	1,030	1,030
	S50-ST-3065-24-UHD-2LF	1	1,675	1,675
	S50-FPI-72-35 (made in 2 pieces)	1	254	254
	WL48	1	115	115
			7,147	
S50-106 WEDGE top 	S50-D-3672-WE-CB-L	1	1,090	1,090
	S50-B-2442-CR-F2B	1	310	310
	S50-CR-2472-CR-BC-R	1	1,694	1,694
				3,094
S50-107 	S50-D-3672-BOW-DB-EP-MP-L	1	1,854	1,854
	S50-B-2442-CR-F2B	1	310	310
	S50-CR-2472-CR-DF-R	1	1,338	1,338
	S50-H-72-35-HD	1	1,030	1,030
	S50-FPI-72-35 (made in 2 pieces)	1	254	254
	WL48	1	115	115
			4,901	
S50-108 WEDGE top 	S50-D-3672-WE-H-L	1	1,280	1,280
	MP for desk	1	168	168
	S50-B-2430-CR-F2B	1	282	282
	S50-CNR-4224-LEFT	1	1,452	1,452
	S50-R-2430-CR-DB-L-S2S	1	1,044	1,044
			4,226	4,226
S50-108 BOW END top 	S50-D-3072-BE-H-L	1	1,117	1,117
	MP for desk	1	168	168
	S50-B-2430-CR-F2B	1	282	282
	S50-CNR-4224-LEFT	1	1,452	1,452
	S50-R-2430-CR-DB-L-S2S	1	1,044	1,044
			4,063	4,063
S50-109 	S50-D-3072-BE-H-L	1	1,117	1,117
	MP for desk	1	168	168
	S50-B-2442-CR-F2B	1	310	310
	S50-CR-2472-CR-DB-R	1	1,338	1,338
	S50-H-72-35-HD	1	1,030	1,030
	S50-FPI-72-35 (made in 2 pieces)	1	254	254
	WL48	1	115	115
			4,332	

On these configurations, we included tasklights (WL36 or WL48) and fabric tackboards with all hutches and overheads
All Series 50 configurations shown here when ordered with WPE WoodPlus edge are available on Magna NOW!

Series 50 Desks

Top shapes available on S50-D models

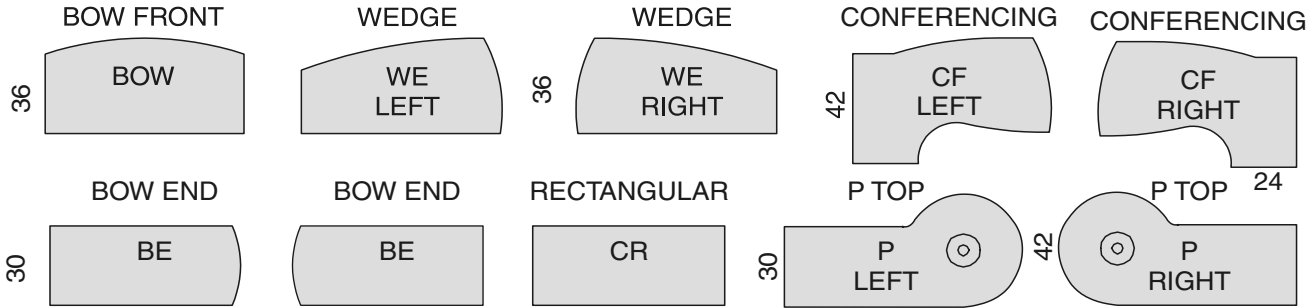

Top edge	WPE, STD	Pricing is for WPE WoodPlus edge, upcharge for STD 3mm wood edge, per top	STD add	100
Edge profile	SM, RE, NEO	SM smooth profile, RE Reeded profile, NEO Neoclassic profile		
Base style	CB, CS	Pricing shown is for the CB Column Black, CS Column Silver bases		
Base style	TS, TB	Upcharges for TB Tapered Black, TS Tapered Silver choices	add	70
Base style	HS, HB	Upcharges for HB HLEG Black, HS HLEG Silver choices	add	176
Modesty Panel	MP	MP Modesty Panel is available with HB or HS bases	add	168
Modesty Panel	MPSF	MPSF Full Shaped Modesty Panel is available with HB or HS base	add	168

Bow End, Wedge and P Top Desks, no storage

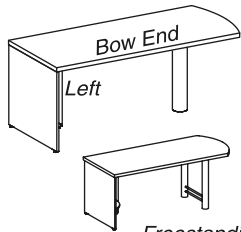

Freestanding BE with H-Leg

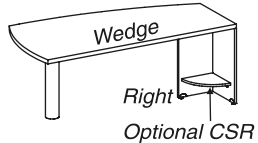

Optional CSR

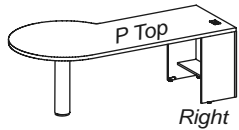

Right

Sizes available for BE top shapes

	Deep	Long	Top	Edge	Profile	Base	L / R	Wt	List
S50-D-	30	60	BE-					96	885
S50-D-	30	66	BE-					102	909
S50-D-	30	72	BE-					108	927

When BE desk is freestanding, use HLEG.

Sizes available for WE top shapes

S50-D-	36	66	WE-					112	1,061
S50-D-	36	72	WE-					119	1,090
								add	48
								add	118

When WE desk is freestanding, use HLEG.

Sizes available for P top shape

S50-D-	42	66	P-					112	1,302
S50-D-	42	72	P-					119	1,349
								add	48

GRE grommet available at 'flat' end of top, centered front to back

Freestanding Bow front desk with pair of H legs

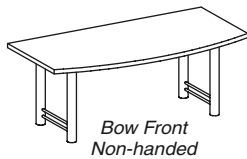

Bow Front Non-handed

	Deep	Long	Top	Edge	Profile	Base u	Wt	List	WPE
S50-D-	36	66	BOW-			HS or HB	104	1,153	
S50-D-	36	72	BOW-			HS or HB	130	1,183	
							add	48	

GREL or GRER, grommet left or right end

MP Modesty Panel or MPSF Shaped Modesty Panel is available with HB, HS bases.

Base u upcharge for HS or HB is included for this Bow Front Desk

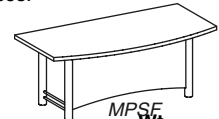

MPSF Wt

Conferencing top, no storage

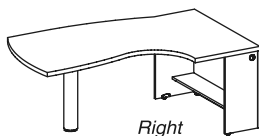

Right

	Deep	Long	Top	Edge	Profile	Base	L / R	Wt	List
S50-D-	42	72	CF-					142	1,304
								add	48

GRE grommet available at 'flat' end of top, centered front to back

When CF desk is freestanding, use HLEG.

Base u upcharge for HB and HS is NOT already included for this Conferencing Desk

All Series 50 models on this page - when ordered with WPE WoodPlus edge - are available on MAGNA NOW! - 10 day ship program

Series 50 Desks

Top edge	WPE, STD	Pricing is for WPE WoodPlus edge, upcharge for STD 3mm wood edge, per top	STD add	100
Edge profile	SM, RE, NEO	SM smooth profile, RE Reeded profile, NEO Neoclassic profile		
Base style	CB, CS	Pricing shown is for the CB Column Black, CS Column Silver bases		
Base style	TS, TB	Upcharges for TB Tapered Black, TS Tapered Silver choices	add	74
Base style	HS, HB	Upcharges for HB HLEG Black, HS HLEG Silver choices	add	176
Modesty Panel	MP	MP Modesty Panel is available with HB or HS columns	add	168
Modesty Panel	MPSF, MPSC	MPSF Full Shaped or MPSC Center Shaped Modesty Panel, horizontal grain	add	168
Pull		Choose pull style for the lower drawers: 10, 12, 13, 14, 15, 18, 19		

Freestanding Desk with single pedestal, locked

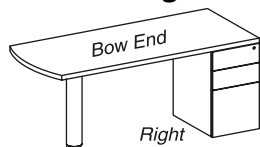

Sizes available for BE top shapes											WPE	
	Deep	Long	Top	Edge	Profile	Ped	Pull	Base	L / R	Wt	List	
S50-D-	30	60	BE-							150	1,506	
S50-D-	30	66	BE-							156	1,530	
S50-D-	30	72	BE-							162	1,548	

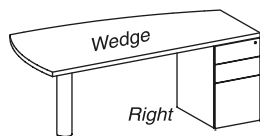

Sizes available for WE top shapes											WPE	
	Deep	Long	Top	Edge	Profile	Ped	Pull	Base	L / R	Wt	List	
S50-D-	36	66	WE-							170	1,694	
S50-D-	36	72	WE-							177	1,723	

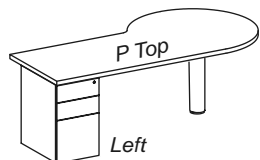

Sizes available for P top shapes											WPE	
	Deep	Long	Top	Edge	Profile	Ped	Pull	Base	L / R	Wt	List	
S50-D-	42	66	P-							170	1,867	
S50-D-	42	72	P-							177	1,914	

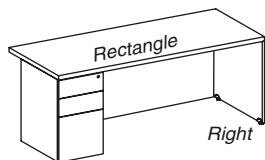

Sizes available for CR top shapes											WPE	
	Deep	Long	Top	Edge	Profile	Ped	Pull	Base	L / R	Wt	List	
S50-D-	30	66	CR-					MP		220	1,376	
S50-D-	30	72	CR-					MP		248	1,396	
S50-D-	36	66	CR-					MP		220	1,503	
S50-D-	36	72	CR-					MP		248	1,617	

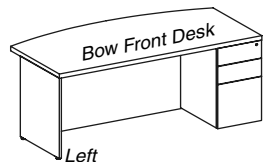

GRE grommet left or right end (NOT available over pedestal) **add** 48
 Continuous Modesty Panel is included; horizontal grain.

Sizes available for BOW top shape											WPE	
	Deep	Long	Top	Edge	Profile	Ped	Pull	Base	L / R	Wt	List	
S50-D-	36	66	BOW-					MP		220	1,744	
S50-D-	36	72	BOW-					MP		238	1,854	

GREL or GREER, grommet left or right end (NOT available over pedestal) **add** 48
 Continuous Modesty Panel is included; horizontal grain.

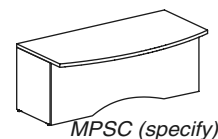
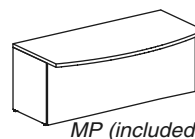
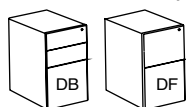

Desk with double pedestals, locked, and Modesty Panel

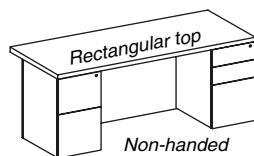

	Deep	Long	Top	Edge	Profile	Ped		Pull	MP	Wt	List
						Left	Right				
S50-D-	30	72	CR-						MP s	281	2,123
S50-D-	36	72	CR-						MP s	296	2,170

Continuous Modesty Panel is included, horizontal grain

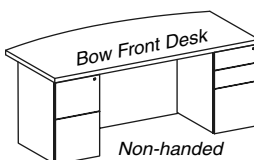

	Deep	Long	Top	Edge	Profile	Ped		Pull	MP	Wt	List
						Left	Right				
S50-D-	36	72	BOW-						MP s	296	2,419

Continuous Modesty Panel is included, horizontal grain

MPSC Center Shaped Modesty Panel, horizontal grain - No upcharge
 MPI Inset Modesty Panel adds finished backs to pedestals, vertical grain **add** 336

All Series 50 models on this page - when ordered with WPE WoodPlus edge - are available on MAGNA NOW! - 10 day ship program

Series 50 Desks

Top shapes available on S50-CNR models

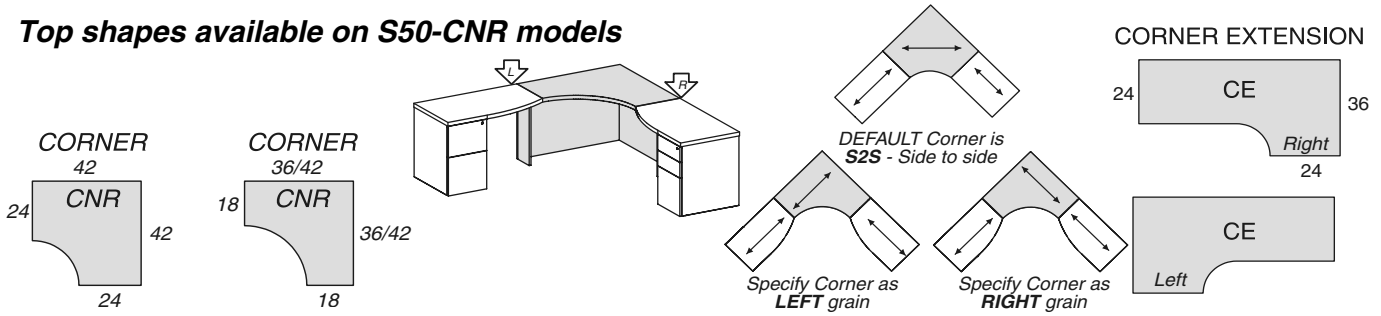

Top edge	WPE, STD	Pricing is for WPE WoodPlus edge, upcharge for STD 3mm wood edge, per top	STD add	100
Edge profile	SM, RE, NEO	SM smooth profile, RE Reeded profile, NEO Neoclassic profile		
Grain	S2S, Left, Right	Grain direction on Corner top: S2S side to side, LEFT matches top to the left, RIGHT matches top to the right		
Modesty Panel	MP	MP Modesty Panel is available	add	168
Pull		Choose pull style for the lower drawers: 10, 12, 13, 14, 15, 18, 19		

Cornes model

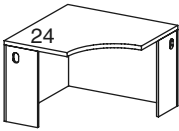
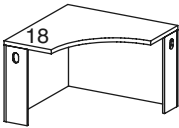

Model	Deep	Ext	Edge	Profile	Grain	Wt	List	
S50-CNR-	36	18				105	1,392	
S50-CNR-	42	18				125	1,452	
S50-CNR-	42	24				125	1,452	
GRC grommet available in corner of top							add	48

S50-CNR-3618 and S50-CNR-4218 connect to the following models

- S50-R-24... Returns with AO tops
- S50-B-24... Bridges with AO tops

S50-CNR-4224 connects to the following models

- S50-B-30... Bridge with AO tops
- S50-B-24... Bridge with CR tops
- S50-R-30... Returns with AO tops
- S50-R-24... Returns with CR tops

Corner extension models, single pedestal, locked

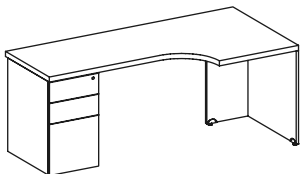

Right shown

	Deep	Long	Top	Edge	Profile	Ped	Pull	L / R	Wt	List
S50-CE-	36	60	CE-						189	1,778
S50-CE-	36	66	CE-						197	1,806
S50-CE-	36	72	CE-						204	1,835
MP Modesty Panel									add	168
GRE grommet available at corner end, centered front to back									add	48

Pedestals

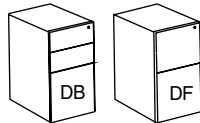

Cabinets

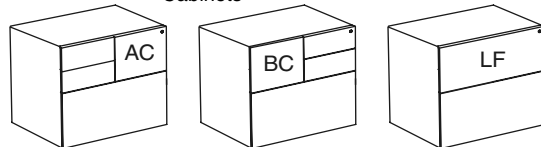

Corner extension models, single cabinet, locked

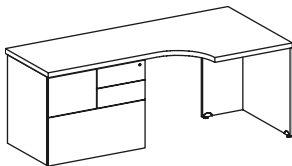

Right shown

	Deep	Long	Top	Edge	Profile	Cab	Pull	L / R	Wt	List
S50-CE-	36	72	CE-						264	2,191
MP Modesty Panel									add	168
GRE grommet available at corner end, centered front to back									add	48

Combo-A and Combo-B are 32" wide, Lateral File is 30" wide

S50-CE connects to the following models with 24" connections:

- S50-B-24 Rectangle CR bridges
- S50-B-30 AO shaped bridges
- S50-R-24 Rectangle CR returns
- S50-R-30 AO shaped returns

All Series 50 models on this page - when ordered with WPE WoodPlus edge - are available on MAGNA NOW! - 10 day ship program

Series 50 Bridges

Top edge	WPE, STD	Pricing is for WPE WoodPlus edge, upcharge for STD 3mm wood edge, per top	STD add	100
Edge profile	SM, RE, NEO	SM smooth profile, RE Reeded profile, NEO Neoclassic profile		
Grain ●	S2S, F2B	Grain on bridge is S2S side to side or F2B front to back		
Modesty Panel	MP	MP Modesty Panel is available (Modesty Panel included for tops 48" and longer)	add	168

Bridge, shaped top: AO

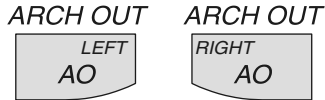

The AO shaped bridge top is set as LEFT or RIGHT when user is seated at corner
For additional information on worktop Left-Right designations, see page 4.

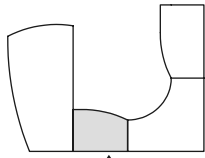

Bridge with shaped top



Bridge top AO uses the 18" deep end to connect to the S50-CNR-__18 corner top

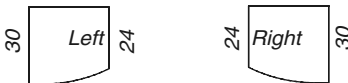

Bridge top AO uses the 24" deep end to connect to the S50-CNR-4224 corner top

	Deep	Long	Top	Edge	Profile	Grain ●	L / R	MP	Wt	List
S50-B-	24	30	AO-						29	531
S50-B-	24	36	AO-						34	544
S50-B-	24	42	AO-						39	557
S50-B-	24	48	AO-					MP	44	725
S50-B-	24	54	AO-					MP	49	740
S50-B-	24	60	AO-					MP	54	756

MP Modesty Panel, vertical grain, is included on 48" and longer for 30", 36", 42" lengths, **add** 168

Bridge top connects at 18 end to corner unit or desk, opposite end is 24 deep

S50-B-	30	30	AO-						35	568
S50-B-	30	36	AO-						42	586
S50-B-	30	42	AO-						48	602
S50-B-	30	48	AO-					MP	54	770
S50-B-	30	54	AO-					MP	60	788
S50-B-	30	60	AO-					MP	67	806

MP Modesty Panel, vertical grain, is included on 48" and longer for 30", 36", 42" lengths, **add** 168

GRC **add** 48

Bridge top connects at 24 end to corner unit or desk, opposite end is 30 deep

Grain ●
S2S = grain runs side to side
F2B = grain runs front to back

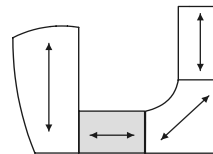

Specify Bridge grain S2S - Side to Side

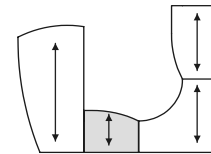

Specify Bridge grain F2B - Front to Back

Bridge, rectangular top: CR

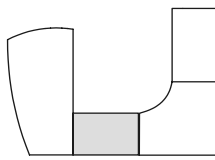
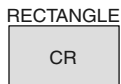

Bridge with Rectangle top



S50-B-24_-CR

Bridge rectangle connects to corner with 24" deep extensions

	Deep	Long	Top	Edge	Profile	Grain ●	MP	Wt	List
S50-B-	24	30	CR-					29	282
S50-B-	24	36	CR-					34	296
S50-B-	24	42	CR-					39	310
S50-B-	24	48	CR-				MP	44	478
S50-B-	24	54	CR-				MP	49	492
S50-B-	24	60	CR-				MP	54	507

MP Modesty Panel, vertical grain, is included on 48" and longer for 30", 36", 42" lengths, **add** 48

GRC **add** 48

Bridge top connects at 24 end to corner unit or desk

Grain ●
S2S = grain runs side to side
F2B = grain runs front to back

All Series 50 models on this page - when ordered with WPE WoodPlus edge - are available on MAGNA NOW! - 10 day ship program

Series 50 Returns

Top shapes available on S50-R models

RECTANGLE RETURNS

LEFT
To the left of user when seated at desk

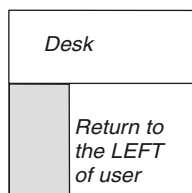

RIGHT
To the right of user when seated at desk

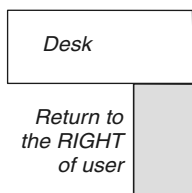

RETURN GRAIN DIRECTION

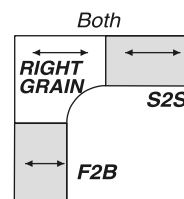
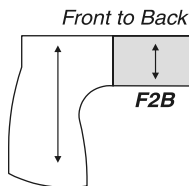
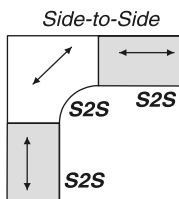

Grain ●
S2S = grain runs side to side
F2B = grain runs front to back

Top edge	WPE, STD	Pricing is for WPE WoodPlus edge, upcharge for STD 3mm wood edge, per top	STD add	100
Edge profile	SM, RE, NEO	SM smooth profile, RE Reeded profile, NEO Neoclassic profile		
Grain ●	S2S, F2B	Grain on return is S2S side to side or F2B front to back		
Modesty Panel	MP	MP Modesty Panel is available	add	168
Pull		Choose pull style for the lower drawers: 10, 12, 13, 14, 15, 18, 19		

For information on worktop Left-Right designations, see page 4.

Returns, no storage

Returns with End Panel

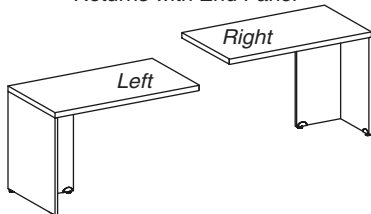

	Deep	Long	Top	Edge	Profile	L/R	MP	Grain ●	Wt	List
S50-R-	24	30	CR-						51	479
S50-R-	24	36	CR-						56	493
S50-R-	24	42	CR-						61	507
S50-R-	24	48	CR-						66	507
S50-R-	24	54	CR-				MP		71	689
S50-R-	24	60	CR-				MP		76	704
									add	168
									add	168
									add	48

MPH Modesty Panel, horizontal grain

MPV Modesty Panel, vertical grain, available up to 60" long

GRE grommet available at panel end of top, centered front to back

Returns, single pedestal locked

Returns with Pedestal

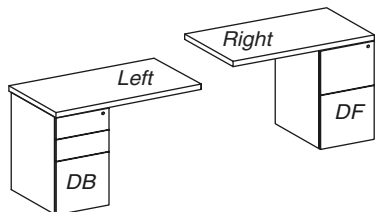

	Deep	Long	Top	Edge	Ped	Pull	L/R	MP	Grain ●	Wt	List
S50-R-	24	30	CR-							109	1,044
S50-R-	24	36	CR-							114	1,058
S50-R-	24	42	CR-							119	1,072
S50-R-	24	48	CR-							124	1,072
S50-R-	24	54	CR-							129	1,086
S50-R-	24	60	CR-					MP		134	1,269
S50-R-	24	66	CR-					MP	S2S	139	1,289
S50-R-	24	72	CR-					MP	S2S	142	1,309
										add	168
										add	168

MPH Modesty Panel, horizontal grain

MPV Modesty Panel, vertical grain, available up to 60" long

Returns single cabinet locked

Returns with Cabinets

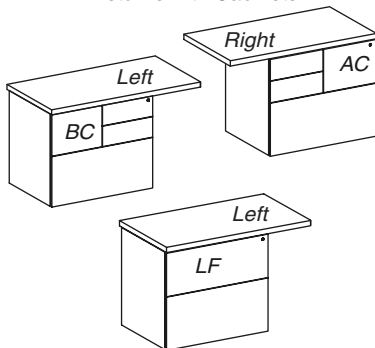

	Deep	Long	Top	Edge	Profile	Cab	Pull	L/R	Grain ●	Wt	List
S50-R-	24	36	CR-							174	1,414
S50-R-	24	42	CR-							179	1,428
S50-R-	24	48	CR-							184	1,428
S50-R-	24	54	CR-							189	1,442
S50-R-	24	60	CR-							194	1,457
S50-R-	24	66	CR-						S2S	199	1,477
S50-R-	24	72	CR-						S2S	204	1,497
										add	168
										add	168

MPH Modesty Panel, horizontal grain

MPV Modesty Panel, vertical grain, available up to 60" long

Combo cabinets are 32" wide.

Lateral files: 36" long returns use LF30, 42" and longer use LF36.

All Series 50 models on this page - when ordered with WPE WoodPlus edge - are available on MAGNA NOW! - 10 day ship program

es 50 Returns

Top shapes available on S50-R models

ARCH OUT RETURNS

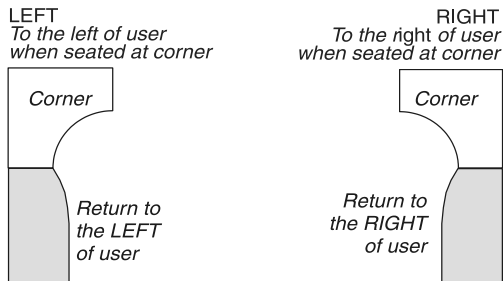

RETURN GRAIN DIRECTION

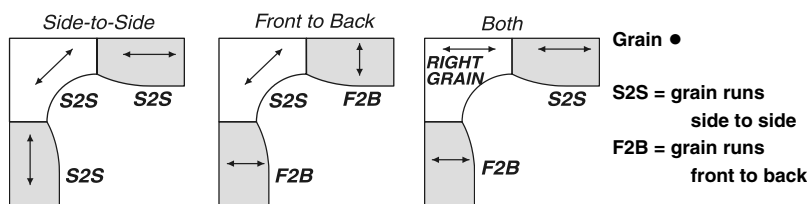

Top edge	WPE, STD	Pricing is for WPE WoodPlus edge, upcharge for STD 3mm wood edge, per top	STD add	100
Edge profile	SM, RE, NEO	SM smooth profile, RE Reeded profile, NEO Neoclassic profile		
Grain •	S2S, F2B	Grain on bridge is S2S side to side or F2B front to back		
Modesty Panel	MP	MP Modesty Panel is available	add	168
Pull		Choose pull style for the lower drawers: 10, 12, 13, 14, 15, 18, 19		

For information on worktop Left-Right designations, see page 4.

Returns with shaped top, no stora

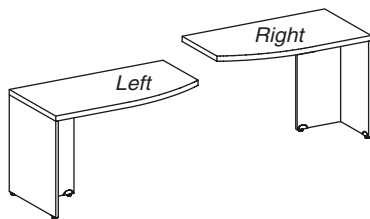

	Deep	Long	Top	Edge	Profile	L / R	MP	Grain •	Wt	List	WPE
S50-R-	24	30	AO-						51	728	
S50-R-	24	36	AO-						56	741	
S50-R-	24	42	AO-						61	754	
S50-R-	24	48	AO-						66	754	
S50-R-	24	54	AO-				MP		71	937	
S50-R-	24	60	AO-				MP		76	953	
S50-R-	24	66	AO-				MP	S2S	81	972	
S50-R-	24	72	AO-				MP	S2S	86	992	
MPH Modesty Panel, horizontal grain									add	168	
MPV Modesty Panel, vertical grain, available up to 60" long									add	168	
GRC grommet available at panel end of top, centered front to back									add	48	

Returns with shaped top, single pedestal locked

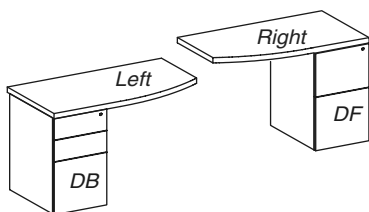

	Deep	Long	Top	Edge	Ped	Pull	L / R	MP	Grain •	Wt	List
S50-R-	24	42	AO-							119	1,319
S50-R-	24	48	AO-							124	1,319
S50-R-	24	54	AO-							129	1,334
S50-R-	24	60	AO-					MP		134	1,518
S50-R-	24	66	AO-					MP	S2S	139	1,537
S50-R-	24	72	AO-					MP	S2S	144	1,557
MPH Modesty Panel, horizontal grain									add	168	
MPV Modesty Panel, vertical grain, available up to 60" long									add	168	

Returns with shaped top, single cabinet locked

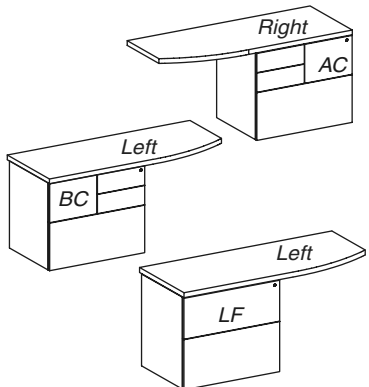

	Deep	Long	Top	Edge	Profile	Cab	Pull	L / R	Grain •	Wt	List	WPE
S50-R-	24	60	AO-							194	1,874	
S50-R-	24	66	AO-						S2S	199	1,893	
S50-R-	24	72	AO-						S2S	204	1,913	
MPH Modesty Panel, horizontal grain									add	168		
MPV Modesty Panel, vertical grain, available up to 60" long									add	168		
Combo-A and Combo-B are 32" wide.												
Lateral files: 60" long returns use LF30, 66" and 72" long returns use LF36.												

All Series 50 models on this page - when ordered with WPE WoodPlus edge - are available on MAGNA NOW! - 10 day ship program

Series 50 Desk Extensions

Top shapes available on S50-DE models

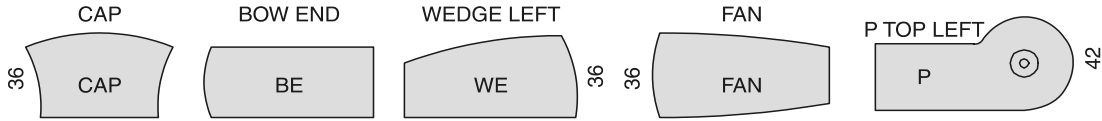

Top edge	WPE, STD	Pricing is for WPE WoodPlus edge, upcharge for STD 3mm wood edge, per top	STD add	100
Edge profile	SM, RE, NEO	SM smooth profile, RE Reeded profile, NEO Neoclassic profile		
Base style	CB, CS	Pricing shown is for the CB Column Black, CS Column Silver bases		
Base style	TS, TB	Upcharges for TB Tapered Black, TS Tapered Silver choices	add	70
Base style	HS, HB	Upcharges for HB HLEG Black, HS HLEG Silver choices	add	176
Modesty Panel	MP	MP Modesty Panel is available with HB or HS columns	add	168
Modesty Panel	MPSH	MPSH Shaped Modesty Panel is available with HB or HS columns	add	168

Desk extensions

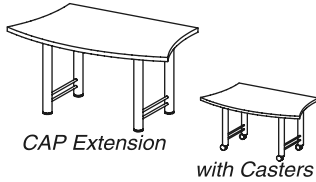

CAP Top sizes

	Deep	Long	Top	Edge	Profile	Base	Grain	Wt	WPE List
S50-T-	48	36	CAP-			H2	F2B	82	1,266
S50-T-	60	36	CAP-			H2	F2B	97	1,324

HS, HB only, Baseu upcharge included for CAP top

Add CASTERS to the CAP Extension

add 84

BE Top sizes

	Deep	Long	Top	Edge	Profile	Baseu		Wt	WPE List
S50-DE-	30	60	BE-					70	676
S50-DE-	30	66	BE-					76	700
S50-DE-	30	72	BE-					82	718

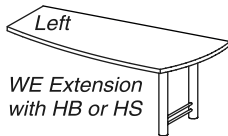
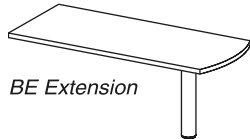

WE Top sizes

	Deep	Long	Top	Edge	Profile	Base	L / R	Wt	WPE List
S50-DE-	36	60	WE-			H		82	836
S50-DE-	36	66	WE-			H		90	864
S50-DE-	36	72	WE-			H		97	893

HB, HS shown

Baseu upcharge NOT already included for WE top

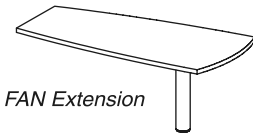

FAN Top sizes

	Deep	Long	Top	Edge	Profile	Base		Wt	WPE List
S50-DE-	36	60	FAN-					82	836
S50-DE-	36	66	FAN-					90	864
S50-DE-	36	72	FAN-					97	893

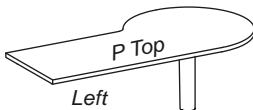

P Top sizes

	Deep	Long	Top	Edge	Profile	Base		Wt	WPE List
S50-DE-	42	66	P-			H		82	1,105
S50-DE-	42	72	P-			H		90	1,152

Office tables



Round top, Column X base

	Diameter	Base	Edge	Profile	Wt	WPE List
S50-TD-	36	COLX			124	1,040
S50-TD-	42	COLX			140	1,176
S50-TD-	48	COLX			155	1,245
S50-TD-	54	COLX			154	1,416
S50-TD-	58	COLX			160	1,525

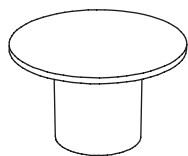

Round top, full cylinder base

	Diameter	Base	Edge	Profile	Wt	WPE List
S50-TD-	36	CYL			124	1,351
S50-TD-	42	CYL			140	1,488
S50-TD-	48	CYL			155	1,535
S50-TD-	54	CYL			154	1,736
S50-TD-	58	CYL			160	2,015

All Series 50 models on this page - when ordered with WPE WoodPlus edge - are available on MAGNA NOW! - 10 day ship program

ries 50 Credenzas

Top edge	WPE, STD	Pricing is for WPE WoodPlus edge, upcharge for STD 3mm wood edge, per top	add	100
Edge profile	SM. RE. NEO	SM smooth profile, RE Reeded profile, NEO Neoclassic profile		
Modesty Panel	MP	MP Modesty Panel is available	add	168
Pull		Choose pull style for the lower drawers: 10, 12, 13, 14, 15, 18, 19		

Top shapes available on S50-CR models

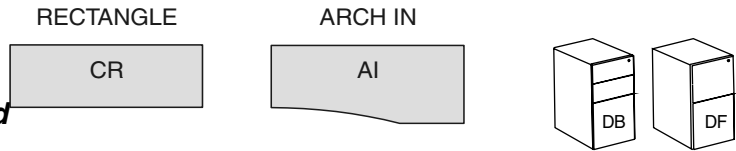

Credenza with single pedestal, locked

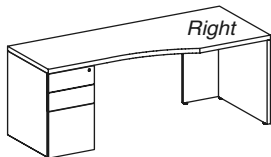
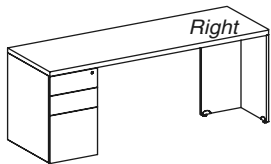

Sizes available for CR tops

Model	Deep	Long	Top	Edge	Profile	Ped	Pull	L / R	Wt	WPE List
S50-CR-	24	60	CR-						156	1,298
S50-CR-	24	66	CR-						161	1,318
S50-CR-	24	72	CR-						166	1,338

Sizes available for AI tops

Model	Deep	Long	Top	Edge	Profile	Ped	Pull	L / R	Wt	WPE List
S50-CR-	30	60	AI-						173	1,609
S50-CR-	30	66	AI-						179	1,633
S50-CR-	30	72	AI-						185	1,651
MP Modesty Panel, horizontal grain									add	168
GRE grommet available at panel end of top, centered front to back									add	48

Credenza with single cabinet, locked

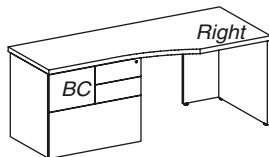
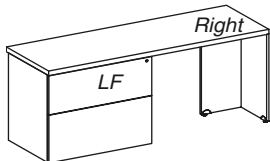
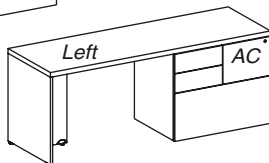
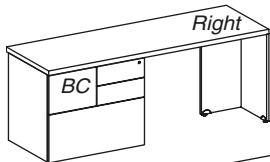
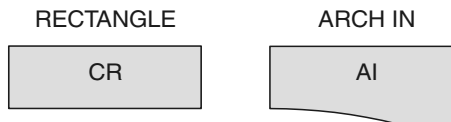

Combo Cabinets are 32" wide
Lateral Files are 36" wide on 60, 66, 72" sizes

Sizes available for CR tops

Model	Deep	Long	Top	Edge	Profile	Cab	Pull	L / R	Wt	WPE List
S50-CR-	24	60	CR-						216	1,654
S50-CR-	24	66	CR-						221	1,674
S50-CR-	24	72	CR-						226	1,694
MP Modesty Panel, horizontal grain									add	168
GRE grommet available at panel end of top, centered front to back									add	48

Sizes available for AI tops

Model	Deep	Long	Top	Edge	Profile	Cab	Pull	L / R	Wt	WPE List
S50-CR-	30	60	AI-						233	1,965
S50-CR-	30	66	AI-						239	1,989
S50-CR-	30	72	AI-						245	2,007
MP Modesty Panel, horizontal grain									add	168
GRE grommet available at panel end of top, centered front to back									add	48

All Series 50 models on this page - when ordered with WPE WoodPlus edge - are available on MAGNA NOW! - 10 day ship program

Series 50 Credenzas

Top edge	WPE, STD	Pricing is for WPE WoodPlus edge, upcharge for STD 3mm wood edge, per top	add	100
Edge profile	SM, RE, NEO	SM smooth profile, RE Reeded profile, NEO Neoclassic profile		
Modesty Panel	MP	MP Modesty Panel is available	add	168
Pull		Choose pull style for the lower drawers: 10, 12, 13, 14, 15, 18, 19	add	168

Top shapes available on S50-CR models RECTANGLE



Locking pedestal with top

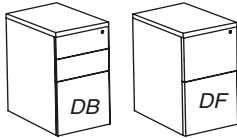

Model	Deep	Long	Top	Edge	Profile	Ped	Pull	Wt	WPE	
									List	
S50-CR-	24	16	CR-					95	1,011	
Includes worksurface top.										

Credenza with double pedestals, locked

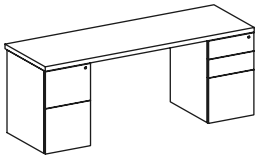

Model	Deep	Long	Top	Edge	Profile	Ped		Pull	Wt	WPE	
						Left	Right			List	
S50-CR-	24	60	CR-						214	1,863	
S50-CR-	24	66	CR-						219	1,883	
S50-CR-	24	72	CR-						224	1,903	
MP Modesty Panel, horizontal grain									add	168	
GRC Center Grommet available									add	48	

Credenza filled with double pedestals, locked and door storage

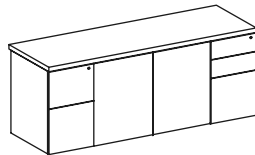

Model	Deep	Long	Top	Edge	Profile	Ped		Pull	Wt	WPE	
						Left	DS			Right	List
S50-CR-	24	60	CR-				DS-		339	2,666	
S50-CR-	24	66	CR-				DS-		352	2,686	
S50-CR-	24	72	CR-				DS-		372	2,706	
MP Modesty Panel, horizontal grain									add	168	
Optional lock available for DS Door Storage									add	87	

Credenza filled with file cabinets, locked

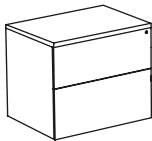

Model	Deep	Long	Top	Edge	Profile	Cab		Pull	Wt	WPE	
						LF				List	
S50-CR-	24	30	CR-			LF			167	1,382	
S50-CR-	24	36	CR-			LF			172	1,396	
Includes one lateral file cabinet for a total of two lateral file drawers											

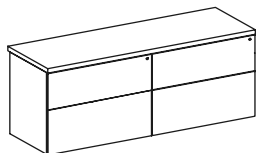

Model	Deep	Long	Top	Edge	Profile	Cab		Pull	Wt	WPE	
						Cab1	Cab2			List	
S50-CR-	24	60	CR-			LF	LF		334	2,575	
S50-CR-	24	72	CR-			LF	LF		202	2,615	
MP Modesty Panel, horizontal grain									add	168	
Includes two lateral file cabinets for a total of four lateral file drawers											

All Series 50 models on this page - when ordered with WPE WoodPlus edge - are available on MAGNA NOW! - 10 day ship program

Series 50 Metal Privacy Screens

Metal privacy screens, perforated pattern A

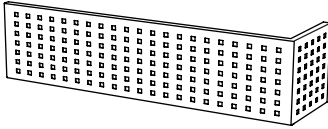

Model	Deep	Long	High	Config	Wt	List
PSM-A-	10	60	10	L	18	480
PSM-A-	10	66	10	L	20	520
PSM-A-	10	72	10	L	21	560
PSM-A-	10	78	10	L	23	600
PSM-A-	10	84	10	L	24	640
PSM-A-	10	90	10	L	26	680
PSM-A-	10	96	10	L	27	720

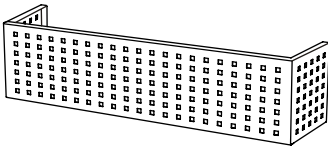

Model	Deep	Long	High	Config	Wt	List
PSM-A-	10	60	10	U	21	560
PSM-A-	10	66	10	U	23	600
PSM-A-	10	72	10	U	24	640
PSM-A-	10	78	10	U	26	680
PSM-A-	10	84	10	U	27	620
PSM-A-	10	90	10	U	29	760
PSM-A-	10	96	10	U	30	800

Screens are attached, as are hutches, with double sided tape. The long end of an L screen must be attached vertically (to a hutch or wall, etc.)

Plan view of L layout

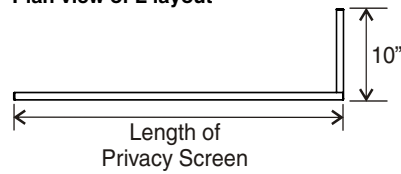

3D view of L layout

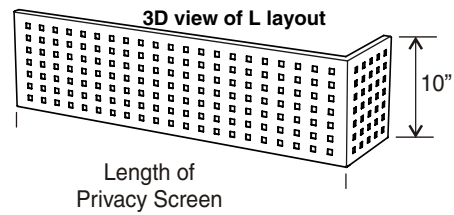

Privacy Screen examples

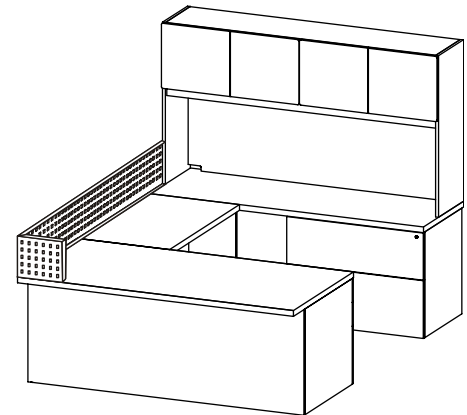
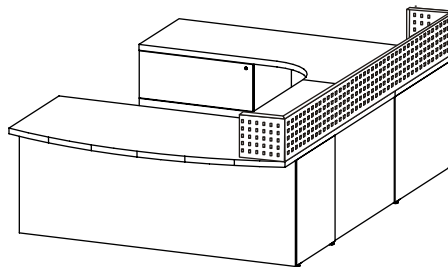

Series 50 Hutches

Hutches with full overlay WoodPlus hinged doors

Wt List



30, 36, 42, 48" wide

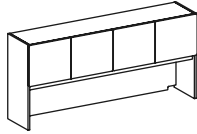

60", 66", 72" wide

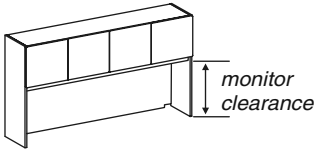

Clearance on 35" high = 15.75"
Clearance on 42" high = 22.75"

Support i.e. end panel, pedestal, cabinet, is required directly below each hutch end.

S50-EP-HUTCH	end panel to support hutch below hutch end	150
--------------	--	-----

	Long	High				
S50-H-	30	35	HD	one pair of doors	86	826
S50-H-	36	35	HD	one pair of doors	93	861
S50-H-	42	35	HD	one pair of doors	102	877
S50-H-	48	35	HD	one pair of doors	112	894
S50-H-	60	35	HD	two pairs of doors	147	980
S50-H-	66	35	HD	two pairs of doors	164	1,004
S50-H-	72	35	HD	two pairs of doors	181	1,030
S50-H-	30	42	HD	one pair of doors	96	843
S50-H-	36	42	HD	one pair of doors	103	880
S50-H-	42	42	HD	one pair of doors	112	897
S50-H-	48	42	HD	one pair of doors	122	916
S50-H-	60	42	HD	two pairs of doors	165	1,031
S50-H-	66	42	HD	two pairs of doors	184	1,064
S50-H-	72	42	HD	two pairs of doors	198	1,092

Hutches with full overlay WoodPlus shaped hinged doors



30, 36, 42, 48" wide

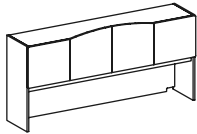

60", 66", 72" wide

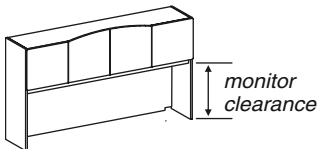

Clearance on 35" high = 15.75"
Clearance on 42" high = 22.75"

Support i.e. end panel, pedestal, cabinet, is required directly below each hutch end.

S50-EP-HUTCH	end panel to support hutch below hutch end	150
--------------	--	-----

	Long	High				
S50-H-	30	35	HSD	one pair of doors	86	905
S50-H-	36	35	HSD	one pair of doors	93	938
S50-H-	42	35	HSD	one pair of doors	102	954
S50-H-	48	35	HSD	one pair of doors	112	972
S50-H-	60	35	HSD	two pairs of doors	147	1,055
S50-H-	66	35	HSD	two pairs of doors	164	1,082
S50-H-	72	35	HSD	two pairs of doors	181	1,106
S50-H-	30	42	HSD	one pair of doors	96	920
S50-H-	36	42	HSD	one pair of doors	103	957
S50-H-	42	42	HSD	one pair of doors	112	976
S50-H-	48	42	HSD	one pair of doors	122	995
S50-H-	60	42	HSD	two pairs of doors	165	1,107
S50-H-	66	42	HSD	two pairs of doors	184	1,139
S50-H-	72	42	HSD	two pairs of doors	198	1,169

No pulls required,
pricing shown is
without pulls on hutch doors

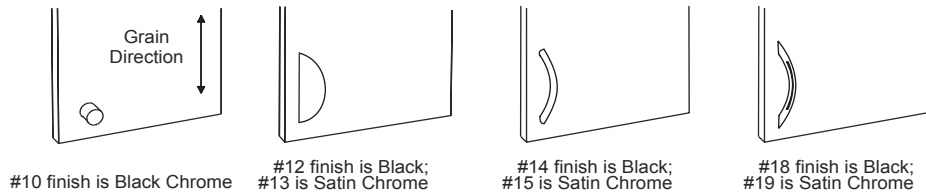

To add pulls to the HD hutch doors

To add pulls to hutches with one pair of doors add	Pull	58
To add pulls to hutches with two pairs of doors add	Pull	91
one pair of doors hutch 30, 36, 42, 48 long	LOCK	87
two pair of doors hutch 60, 66, 72 long	LOCK	175

Locks are available

All above Series 50 HD or HSD hutches on this page are available on MAGNA NOW! - 10 day ship program

Series 50 Hutches

Hutches with full overlay Frosted Glass Doors with WoodPlus2 frames

Support i.e. end panel, pedestal, cabinet, is required directly below each hutch end.

S50-EP-HUTCH	end panel to support hutch below hutch end	150
--------------	--	-----

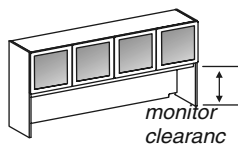
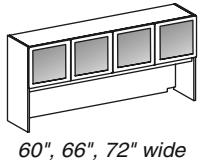
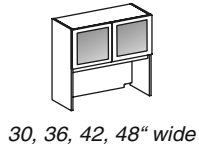

Clearance on 35" high = 15.75"
Clearance on 42" high = 22.75"

	Long	High	WoodPlus and Glass		Wt	WPE List
S50-H-	30	35	GDW	one pair doors	86	1,143
S50-H-	36	35	GDW	one pair doors	93	1,177
S50-H-	42	35	GDW	one pair doors	102	1,194
S50-H-	48	35	GDW	one pair doors	112	1,211
S50-H-	60	35	GDW	two pair doors	147	1,610
S50-H-	66	35	GDW	two pair doors	164	1,636
S50-H-	72	35	GDW	two pair doors	181	1,661
S50-H-	30	42	GDW	one pair doors	96	1,160
S50-H-	36	42	GDW	one pair doors	103	1,196
S50-H-	42	42	GDW	one pair doors	112	1,215
S50-H-	48	42	GDW	one pair doors	122	1,233
S50-H-	60	42	GDW	two pair doors	165	1,662
S50-H-	66	42	GDW	two pair doors	184	1,692
S50-H-	72	42	GDW	two pair doors	198	1,722

Pulls and Locks not available on Glass Doors

Door frame detailing matches HD Hinged Door detailing.

Choose door frame finish from the current WoodPlus2 door finishes.

Door frame finish may be chosen from the current WoodPlus2 XTRA door finishes

for List \$600 per order charge.

Optional CLEAR glass doors . . . Add \$210 per unit.

Hutches with full overlay Aluminum frame Frosted Glass Doors hinged doors

Support i.e. end panel, pedestal, cabinet, is required directly below each hutch end.

S50-EP-HUTCH	end panel to support hutch below hutch end	150
--------------	--	-----

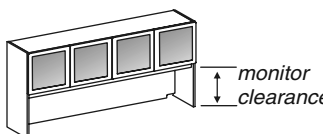
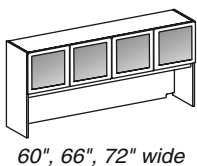
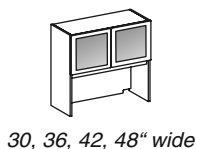

Clearance on 35" high = 15.75"
Clearance on 42" high = 22.75"

	Long	High	Aluminum Frames		Wt	WPE List
S50-H-	30	35	GDA	one pair doors	86	1,207
S50-H-	36	35	GDA	one pair doors	93	1,299
S50-H-	42	35	GDA	one pair doors	102	1,371
S50-H-	48	35	GDA	one pair doors	112	1,527
S50-H-	60	35	GDA	two pair doors	147	1,782
S50-H-	66	35	GDA	two pair doors	164	1,867
S50-H-	72	35	GDA	two pair doors	181	1,953
S50-H-	30	42	GDA	one pair doors	96	1,222
S50-H-	36	42	GDA	one pair doors	103	1,316
S50-H-	42	42	GDA	one pair doors	112	1,391
S50-H-	48	42	GDA	one pair doors	122	1,548
S50-H-	60	42	GDA	two pair doors	165	1,830
S50-H-	66	42	GDA	two pair doors	184	1,920
S50-H-	72	42	GDA	two pair doors	198	2,010

GDA: Doors are Brushed Aluminum Frame with Frosted Glass.

Optional CLEAR glass doors . . . Add \$210 per unit.

Pulls and Locks not available on Glass Doors

The Series 50 GDW or GDA hutches on this page are NOT available on MAGNA NOW! - 10 day ship program

Series 50 Hutches

Hutches open



30", 36", 42", 48" wide

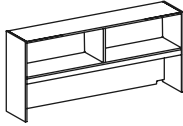

60", 66", 72" wide

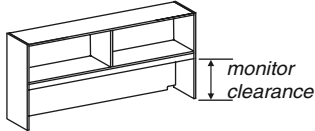

Clearance on 35" high = 15.75"
Clearance on 42" high = 22.75"

Tackboards for hutch

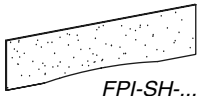

Support i.e. end panel, pedestal, cabinet, is required directly below each hutch end.

					WPE	
					Wt	List
S50-EP-HUTCH	end panel to support hutch below hutch end				150	
Long	High				Wt	List
S50-H-	30	35	OPEN	one section	65	620
S50-H-	36	35	OPEN	one section	70	646
S50-H-	42	35	OPEN	one section	77	658
S50-H-	48	35	OPEN	one section	84	670
S50-H-	60	35	OPEN	two sections	110	735
S50-H-	66	35	OPEN	two sections	123	753
S50-H-	72	35	OPEN	two sections	136	772
S50-H-	30	42	OPEN	one section	72	632
S50-H-	36	42	OPEN	one section	77	660
S50-H-	42	42	OPEN	one section	84	673
S50-H-	48	42	OPEN	one section	92	687
S50-H-	60	42	OPEN	two sections	124	773
S50-H-	66	42	OPEN	two sections	138	798
S50-H-	72	42	OPEN	two sections	149	819

Long	High	Description	Wt	List
S50-FPI		for 30, 36, 42, 48, 54, 60 long hutches	14	222
S50-FPI		for 66, 72 long hutches	14	254
S50-FPI-SH		for 30, 36, 42, 48, 54, 60 long hutches	14	222
S50-FPI-SH		for 66, 72 long hutches	14	254

S50-FPI models at 72" long are made in two pieces
Include Guilford Fabric Style number and Color number
Pricing shown is for Magna Design fabric grades A, B, C only.

The following Guilford fabrics are available for MAGNA NOW! Orders:

Hopscotch 2823-014 TicTacToe	Orissa 2818-010 Kashmir
Raku 3548-040 Prism	FR701 2100-380 Quartz
Raku 3548-020 Porcelain	FR701 2100-390 Rose Quartz
Raku 3548-060 Green	Belgrade 4052-053 Bluehill

Shaped valance on hutch

available at no charge to complement the curve on the top of shaped hinged doors
or the bottom of the shaped tackboard

-VALSH	matches hutch length	NC
--------	----------------------	----

Paper shelf

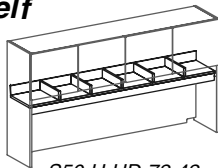

S50-H-HD-72-42
with S50-PSS

order as an option to a hutch

Long		
-PSS	matches hutch length	22 192

ONLY available on 42" high hutches.

Paper organizer and tray inserts



DTO Desktop organizer.
Shown with 3 optional trays.

DTO is 15" wide x 10.75" deep
Tray inside dimensions:
12.875 w x 8.625 d x 2.25 h

Slots	Wt	List
DTO-5 5 fits 35" high hutch or 42" high hutch with PSS	18	274
DTO-6 6 fits 42" high hutch	19	274

DTO-TRAY-ABS	black	fits into any DTO slot	2	46
--------------	-------	------------------------	---	----

Has a cutout on the front. No applied WoodPlus / ColorPlus face.

DTO-TRAY-FACE	Pull	Finish	Wt	List
			3	67

Includes the DTO-TRAY-ABS and the applied WoodPlus / ColorPlus face

Specify Pull #	Pull 9 is black	matches color finish of Pull 12, 14, 18
	Pull 10 is black chrome	matches color finish of Pull 10
	Pull 11 is satin chrome	matches color finish of Pull 13, 15, 19

All Series 50 models on this page are available on MAGNA NOW! - 10 day ship program

Series 50 overhead cabinets, wall mounted

Hinged Door cabinets, wall mounted, Tech style: top, back, bottom, valance are black

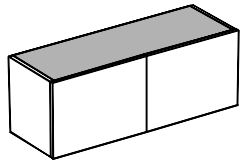

Wall Mount, 30" to 60" Wide

		Pull		Wt	WPE List
S50-HDT30-WK			one pair of doors	46	622
S50-HDT36-WK			one pair of doors	53	676
S50-HDT42-WK			one pair of doors	60	726
S50-HDT48-WK			one pair of doors	67	757
<hr/>					
S50-HDT54-WK			two pair of doors	74	933
S50-HDT60-WK			two pair of doors	81	948
<hr/>					
Locks are available		one pair of doors	30 to 48 long	add	87
		two pair of doors	54 to 60 long	add	174

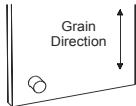

#10 finish is Black Chrome



#12 finish is Black; #13 is Satin Chrome



#14 finish is Black; #15 is Satin Chrome

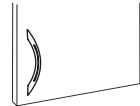

#18 finish is Black; #19 is Satin Chrome

Pull			length	length
			30 - 48	54 - 60
T	touch latch (no pull)	add	0	0
10	Black chrome knob	add	61	96
12	Black	add	61	96
13	Satin chrome	add	61	96
14	Black	add	61	96
15	Satin chrome	add	61	96
18	Black	add	61	96
19	Satin chrome	add	61	96

Glass Hinged Doors with Aluminum frame, wall mounted cabinets, Tech style

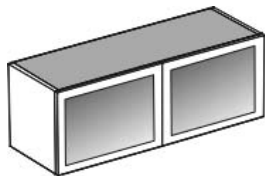

			Wt	WPE List
S50-GDAT30-WK		one pair of doors	46	1,003
S50-GDAT36-WK		one pair of doors	53	1,114
S50-GDAT42-WK		one pair of doors	60	1,220
S50-GDAT48-WK		one pair of doors	67	1,390
<hr/>				
S50-GDAT54-WK		two pair of doors	74	1,735
S50-GDAT60-WK		two pair of doors	81	1,750

Pulls and Locks not available on Glass Doors

GDA: Doors are Brushed Aluminum Frame with Frosted Glass.

Optional CLEAR glass doors Add \$210 per unit.

Glass Hinged Doors with WoodPlus2 frame, wall mounted cabinets, Tech style

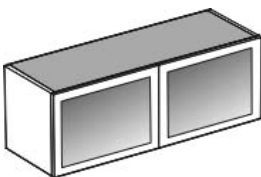

			Wt	WPE List
S50-GDWT30-WK		one pair of doors	46	939
S50-GDWT36-WK		one pair of doors	53	992
S50-GDWT42-WK		one pair of doors	60	1,043
S50-GDWT48-WK		one pair of doors	67	1,074
<hr/>				
S50-GDWT54-WK		two pair of doors	74	1,563
S50-GDWT60-WK		two pair of doors	81	1,578

Pulls and Locks not available on Glass Doors

Choose door frame finish from the current WoodPlus2 door finishes.

Door frame finish may be chosen from the current WoodPlus2 XTRA door finishes

for List \$600 per order charge.

Optional CLEAR glass doors Add \$210 per unit.

Flipper Door cabinets, wall mounted

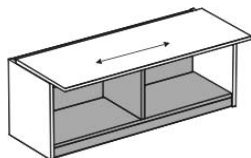

Grain Direction on Door shown

			Wt	WPE List	
S50-FDT30-WK		one door	46	622	
S50-FDT36-WK		one door	53	676	
S50-FDT42-WK		one door	60	726	
S50-FDT48-WK		one door	67	757	
<hr/>					
S50-FDT54-WK		two doors	74	933	
S50-FDT60-WK		two doors	81	948	
<hr/>					
Locks are available		one door	30 to 48 long	add	87
		two doors	54 to 60 long	add	175

No pull available

Only S50-HDT.. and S50-FDT.. models on this page are available on MAGNA NOW! - 10 day ship program

Series 50 overhead cabinets, wall mounted

Tackboards, wall mounted

Use 18" high tackboard between wall mounted overhead
and worksurface when the top of the overhead is approximately 65" high
Use 25" high tackboard between wall mounted overhead
and worksurface when the top of the overhead is approximately 72" high

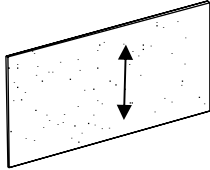

	List
18H x 30-60L	222
25H x 30-60L	222
26-48H x 60L	254

Specify Guilford Style and Color numbers. For panels longer than 60", order 2 panels.

	Long	High	Style	Color	
FPW-					

Pricing is for Magna Design fabric grades A, B, C only.

Please contact customer service for price of other fabric grades.

Cord covers with matching fabric available with any FPW- Tackboard, no charge

The following Guilford fabrics are available for MAGNA NOW! Orders:

Hopscotch 2823-014 TicTacToe	Orissa 2818-010 Kashmir
Raku 3548-040 Prism	FR701 2100-380 Quartz
Raku 3548-020 Porcelain	FR701 2100-390 Rose Quartz
Raku 3548-060 Green	Belgrade 4052-053 Bluehill

Tasklights



	List
WL24	79
WL30	86
WL36	99
WL42	108
WL48	115

All Series 50 models on this page are available on MAGNA NOW! - 10 day ship program

Series 50 Towers

Top edge	WPE, STD	Pricing is for WPE WoodPlus edge, upcharge for STD 3mm wood edge, per top	add	100
Edge profile	SM, RE, NEO	SM smooth profile, RE Reeded profile, NEO Neoclassic profile		
Lower Ped	DB, DF	DB is Box Box File with lock; DF is File File with lock		
Lower LF	2LF	Two Lateral File drawers with lock		
Lower Pull	price included	Choose pull style for the pedestal or lateral file drawers: 10, 12, 13, 14, 15, 18, 19		
Lock for doors		Optional lock available for all doors	add	87
Upper Pull	T,10,12,13,14,15,18,19	Price shown is for T Touch latch on upper doors		
		to add a pull to a single upper door, each	add	29
		to add a pull to a pair of upper doors, pair	add	58

Towers with upper open shelves and locking lower drawers

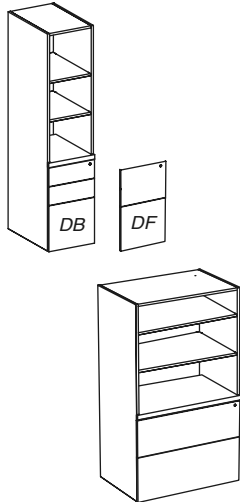

	Wide	High	Deep	Upper section	Edge	Profile	Lower Drawers	Lower Pull	Wt	WPE List
S50-ST-	16	65	24	OPEN					135	1,427
S50-ST-	16	72	24	OPEN					142	1,464

	Wide	High	Deep	Upper section	Edge	Profile	Lower Drawers	Lower Pull	Wt	WPE List
S50-ST-	30	65	24	OPEN			2LF-		228	1,488
S50-ST-	36	65	24	OPEN			2LF-		288	1,523
S50-ST-	30	72	24	OPEN			2LF-		285	1,508
S50-ST-	36	72	24	OPEN			2LF-		317	1,550

Edge profiles:

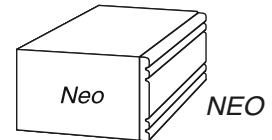
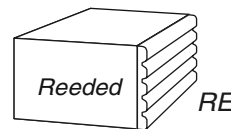
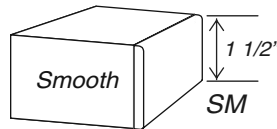

3mm WoodPlus PVC designation
3mm Standard hardwood edge

WPFS
SWFS

WPFR
SWFR

WPFN
SWFN

Towers with upper hinged doors and locking lower drawers

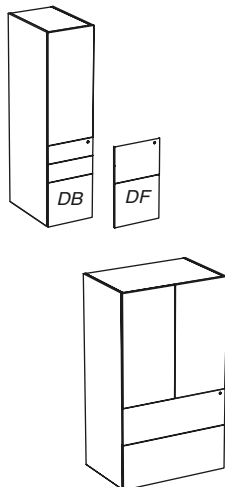

	Wide	High	Deep	Upper section	Hinge L or R	Lower Drawers	Lower Pull	Wt	WPE List	
S50-ST-	16	65	24	UHD				135	1,427	
S50-ST-	16	72	24	UHD				142	1,464	
S50-ST-	30	65	24	UHD		2LF-		228	1,675	
S50-ST-	36	65	24	UHD		2LF-		288	1,711	
S50-ST-	30	72	24	UHD		2LF-		285	1,696	
S50-ST-	36	72	24	UHD		2LF-		317	1,737	
Lock for Upper Hinged Door(s)									add	87

All Series 50 models on this page - when ordered with WPE WoodPlus edge - are available on MAGNA NOW! - 10 day ship program

Series 50 Towers

Top edge	WPE, STD	Pricing is for WPE WoodPlus edge, upcharge for STD 3mm wood edge, per top	add	100
Edge profile	SM, RE, NEO	SM smooth profile, RE Reeded profile, NEO Neoclassic profile		
Lower Ped	DB, DF	DB is Box Box File with lock; DF is File File with lock		
Lower LF	2LF	Two Lateral File drawers with lock		
Lower Pull		Choose pull style for the pedestal or lateral file drawers: 10, 12, 13, 14, 15, 18, 19		

Towers with upper Frosted Glass doors in WoodPlus2 frames and locking lower drawers

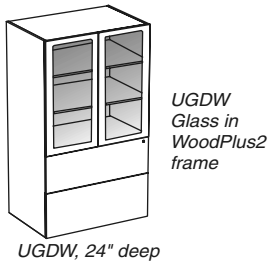
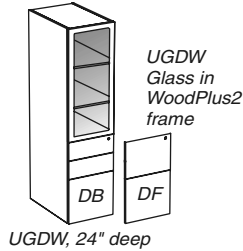

	Wide	High	Deep	Glass Door	Hinge L / R	Lower Ped	Lower Pull	Wt	WPE List
S50-ST-	16	65	24	UGDW				135	1,674
S50-ST-	16	72	24	UGDW				142	1,722

	Wide	High	Deep	Glass Door	Lower Drawers	Lower Pull	Wt	WPE List
S50-ST-	30	65	24	UGDW	2LF-		228	2,167
S50-ST-	36	65	24	UGDW	2LF-		288	2,264
S50-ST-	30	72	24	UGDW	2LF-		285	2,268
S50-ST-	36	72	24	UGDW	2LF-		317	2,379

Choose door frame finish from the current WoodPlus2 door finishes.
 Door frame finish may be chosen from the current WoodPlus2 XTRA door finishes for List \$600 per order charge.

Glass is inset in WoodPlus2 frame. No pull or lock on glass door(s)
 Optional CLEAR glass doors . . . Add \$210 per unit.

Towers with upper Frosted Glass doors in Aluminum frames and locking lower drawers

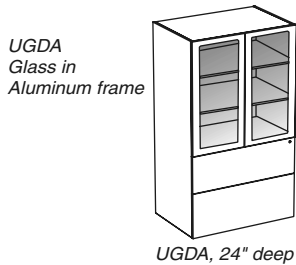
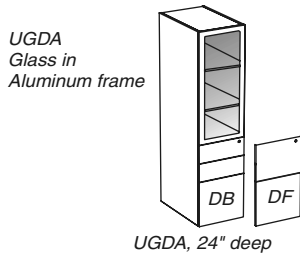

	Wide	High	Deep	Glass Door	Hinge L / R	Lower Ped	Lower Pull	Wt	WPE List
S50-ST-	16	65	24	UGDA				135	2,033
S50-ST-	16	72	24	UGDA				135	2,220

	Wide	High	Deep	Glass Door	Lower Drawers	Lower Pull	Wt	WPE List
S50-ST-	30	65	24	UGDA	2LF-		228	2,604
S50-ST-	36	65	24	UGDA	2LF-		288	2,752
S50-ST-	30	72	24	UGDA	2LF-		285	2,772
S50-ST-	36	72	24	UGDA	2LF-		317	2,987

Glass is inset in Aluminum frame. No pull or lock on glass door(s)
 Optional CLEAR glass doors . . . Add \$210 per unit.

All of the Series 50 models on this page are NOT available on MAGNA NOW! - 10 day ship program

Series 50 Towers

Top edge	WPE, STD	Pricing is for WPE WoodPlus edge, upcharge for STD 3mm wood edge, per top	add	100
Edge profile	SM, RE, NEO	SM smooth profile, RE Reeded profile, NEO Neoclassic profile		
Lower Pull		Choose pull style for the pedestal or lateral file drawers: 10, 12, 13, 14, 15, 18, 19		
Lock for doors		Optional lock available for single or one pair of doors	add	87
		Optional lock available for two pairs of doors	add	175
Upper Pull	T,10,12,13,14,15,18, 19	Price shown is for T Touch latch on upper doors		
		for single door	add	29
		for pair of doors	add	58

Towers with upper and lower doors

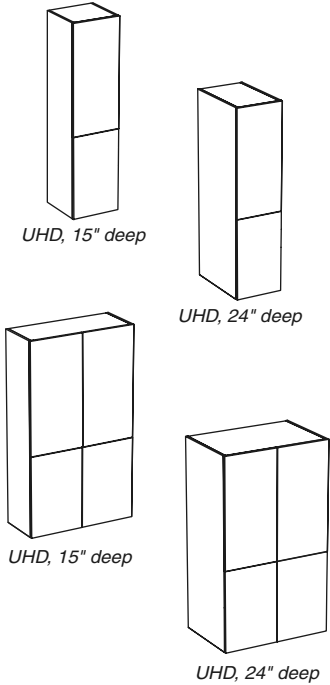

	Wide	High	Deep	Upper Door	Upper Pull	Hinge L / R	Lower Door	Lower Pull	Wt	WPE List
S50-ST-	16	65	15	UHD			LHD-		103	1,146
S50-ST-	16	72	15	UHD			LHD-		110	1,180
S50-ST-	16	65	24	UHD			LHD-		125	1,207
S50-ST-	16	72	24	UHD			LHD-		132	1,243
Upper Pull										
S50-ST-	30	65	15	UHD			LHD-		215	1,329
S50-ST-	36	65	15	UHD			LHD-		228	1,363
S50-ST-	30	72	15	UHD			LHD-		226	1,350
S50-ST-	36	72	15	UHD			LHD-		257	1,388
S50-ST-	30	65	24	UHD			LHD-		259	1,399
S50-ST-	36	65	24	UHD			LHD-		288	1,434
S50-ST-	30	72	24	UHD			LHD-		285	1,421
S50-ST-	36	72	24	UHD			LHD-		317	1,462
Lock for Upper Hinged Door(s)									add	175

Towers with upper open shelves and with lower doors

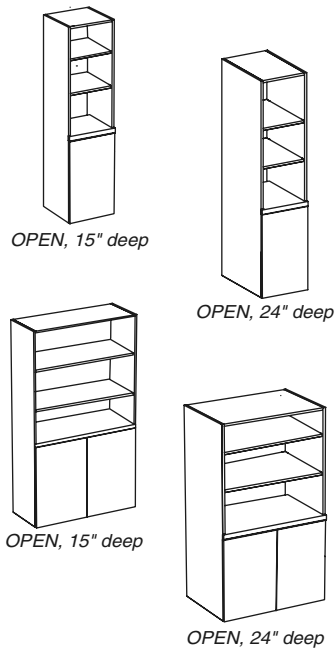

	Wide	High	Deep	Edge	Profile	Hinge L/R	Lower Door	Lower Pull	Wt	WPE List
S50-ST-	16	65	15	OPEN			LHD-		103	1,146
S50-ST-	16	72	15	OPEN			LHD-		110	1,180
S50-ST-	16	65	24	OPEN			LHD-		135	1,207
S50-ST-	16	72	24	OPEN			LHD-		142	1,243
Lock for Hinged Doors									add	87
Lower Door Pull										
S50-ST-	30	65	15	OPEN			LHD-		215	1,141
S50-ST-	36	65	15	OPEN			LHD-		228	1,176
S50-ST-	30	72	15	OPEN			LHD-		226	1,161
S50-ST-	36	72	15	OPEN			LHD-		257	1,200
S50-ST-	30	65	24	OPEN			LHD-		228	1,211
S50-ST-	36	65	24	OPEN			LHD-		288	1,247
S50-ST-	30	72	24	OPEN			LHD-		285	1,230
S50-ST-	36	72	24	OPEN			LHD-		317	1,274

Open units include worksurface top; specify edge profile.

All Series 50 models on this page - when ordered with WPE WoodPlus edge - are available on MAGNA NOW! - 10 day ship program

Series 50 Towers

Towers with WoodPlus2 frame upper Frosted Glass doors

Lower Pull

Choose pull style for the lower hinged door(s): 10, 12, 13, 14, 15, 18, 19

N/C

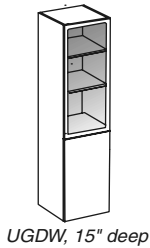

UGDW
Glass inset in
WoodPlus2 frame

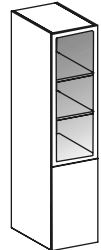

UGDW, 24" deep

	Wide	High	Deep	Glass Door	Hinge L / R	Lower Door	Lower Pull	Wt	WPE List	
S50-ST-	16	65	15	UGDW		LHD-		103	1,393	
S50-ST-	16	72	15	UGDW		LHD-		110	1,440	
S50-ST-	16	65	24	UGDW		LHD-		125	1,452	
S50-ST-	16	72	24	UGDW		LHD-		132	1,497	
To lock the Lower Hinged Doors, change LHD to LHDL								one door	add	87

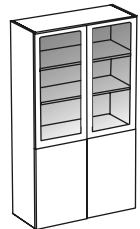

UGDW, 15" deep

UGDW
Glass inset in
WoodPlus2 frame

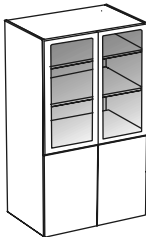

UGDW, 24" deep

Glass door									
	Wide	High	Deep	Glass Door	Hinge L / R	Lower Door	Lower Pull	Wt	WPE List
S50-ST-	30	65	15	UGDW		LHD-		215	1,822
S50-ST-	36	65	15	UGDW		LHD-		228	1,915
S50-ST-	30	72	15	UGDW		LHD-		226	1,921
S50-ST-	36	72	15	UGDW		LHD-		257	2,030
S50-ST-	30	65	24	UGDW		LHD-		259	1,892
S50-ST-	36	65	24	UGDW		LHD-		288	1,986
S50-ST-	30	72	24	UGDW		LHD-		285	1,993
S50-ST-	36	72	24	UGDW		LHD-		317	2,104
To lock the Lower Hinged Doors, change LHD to LHDL								add	87

Choose door frame finish from the current WoodPlus2 door finishes.

Door frame finish may be chosen from the current WoodPlus2 XTRA door finishes for List \$600 per order charge.

No lock or pull available on Glass Doors. Optional CLEAR glass doors . .Add \$210 per unit.

Towers with Aluminum frame upper Frosted Glass doors

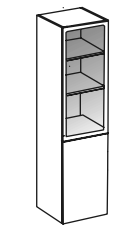

UGDA, 15" deep

UGDA
Glass inset in
Aluminum frame

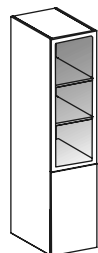

UGDA, 24" deep

	Wide	High	Deep	Glass Door	Hinge L / R	Lower Door	Lower Pull	Wt	WPE List
S50-ST-	16	65	15	UGDA		LHD-		135	1,752
S50-ST-	16	72	15	UGDA		LHD-		103	1,785
S50-ST-	16	65	24	UGDA		LHD-		142	1,811
S50-ST-	16	72	24	UGDA		LHD-		142	2,000

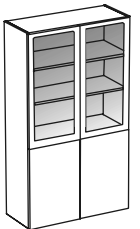

UGDA, 15" deep

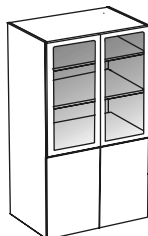

UGDA, 24" deep

Glass door									
	Wide	High	Deep	Glass Door	Hinge L / R	Lower Door	Lower Pull	Wt	WPE List
S50-ST-	30	65	15	UGDA		LHD-		215	2,257
S50-ST-	36	65	15	UGDA		LHD-		228	2,405
S50-ST-	30	72	15	UGDA		LHD-		226	2,426
S50-ST-	36	72	15	UGDA		LHD-		257	2,639
S50-ST-	30	65	24	UGDA		LHD-		228	2,328
S50-ST-	36	65	24	UGDA		LHD-		288	2,476
S50-ST-	30	72	24	UGDA		LHD-		285	2,497
S50-ST-	36	72	24	UGDA		LHD-		317	2,711
To LOCK the Lower Hinged Doors, change LHD to LHDL								add	87

No lock or pull available on Glass Doors. Optional CLEAR glass doors . .Add \$210 per unit.

All of the Series 50 models on this page are NOT available on MAGNA NOW! - 10 day ship program

Series 50 Towers

Top edge	WPE, STD	Pricing is for WPE WoodPlus edge, upcharge for STD 3mm wood edge, per top	add	100
Edge profile	SM, RE, NEO	SM smooth profile, RE Reeded profile, NEO Neoclassic profile		
Pull		Choose pull style for the pedestal or lateral file drawers: 10, 12, 13, 14, 15, 18, 19		

Towers with locking lateral file drawers with worksurface top

WPE

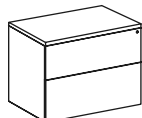

S50-ST36-29-24-2LF

	Wide	High	Deep	Edge	Profile	Pull	Wt	List	
S50-ST-	30	29	24	2LF-			-TOP	167	1,382
S50-ST-	36	29	24	2LF-			-TOP	172	1,397

Includes worksurface top; specify edge profile

Edge profiles:

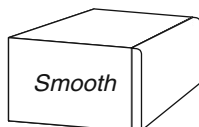

1 1/2"
SM

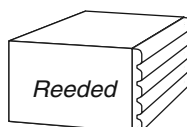

RE

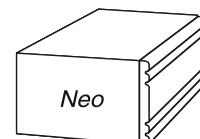

NEO

3mm WoodPlus PVC designation
3mm Standard hardwood edge

WPFS
SWFS

WPFR
SWFR

WPFN
SWFN

Towers with locking lateral file drawers

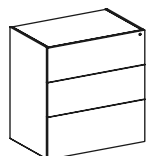

S50-ST36-41-24-3LF

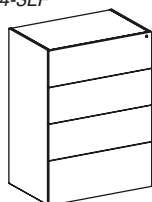

S50-ST36-53-24-4LF

	Wide	High	Deep	Edge	Profile	Pull	Wt	List
S50-ST-	30	41	24	3LF-			281	1,288
S50-ST-	30	53	24	4LF-			288	1,550

Full overlay drawer faces

	Wide	High	Deep	Edge	Profile	Pull	Wt	List
S50-ST-	36	41	24	3LF-			291	1,337
S50-ST-	36	53	24	4LF-			298	1,624

Full overlay drawer faces

Top for 3 drawer or 4 drawer lateral file (matches worksurface detailing)

	Wide	High	Deep	Edge	Profile	Grain	Wt	List
S50-TOP-CR-	24	30				S2S	25	246
S50-TOP-CR-	24	36				S2S	30	260

All Series 50 models on this page - when ordered with WPE WoodPlus edge - are available on MAGNA NOW! - 10 day ship program

Series 50 Towers

Locking Lateral file with hutch

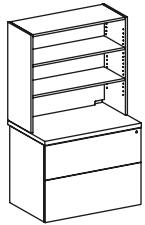

Bookshelf hutch

Hinged Door hutch

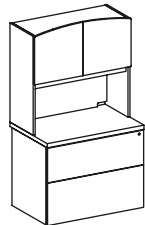
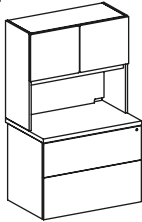

Shaped Door hutch

						Edge	Profile	Lower Pull		
S50-HLF-	30N	65	24	2LF-	BS				253	2,033
S50-HLF-	30N	72	24	2LF-	BS				263	2,050
S50-HLF-	36N	65	24	2LF-	BS				265	2,081
S50-HLF-	36N	72	24	2LF-	BS				275	2,100

						Edge	Profile	Upper Pull	Lower Pull		
S50-HLF-	30N	65	24	2LF-	HD					253	2,208
S50-HLF-	30N	72	24	2LF-	HD					263	2,225
S50-HLF-	36N	65	24	2LF-	HD					265	2,257
S50-HLF-	36N	72	24	2LF-	HD					275	2,276
HD-L	Locks for HD Hinged doors									add	87

						Edge	Profile	Upper Pull	Lower Pull		
S50-HLF-	30N	65	24	2LF-	HSD					253	2,287
S50-HLF-	30N	72	24	2LF-	HSD					263	2,302
S50-HLF-	36N	65	24	2LF-	HSD					265	2,334
S50-HLF-	36N	72	24	2LF-	HSD					275	2,353

30N Nominal width is 30". Actual width is 29.75". Does not support standard width hutch at 30".
36N Nominal width is 36". Actual width is 35.75". Does not support standard width hutch at 36".

All the above Series 50 models - when ordered with WPE WoodPlus edge - are available on MAGNA NOW! - 10 day ship program

Locking Lateral file and hutch with Frosted Glass Doors

Glass Doors WoodPlus2 Frames

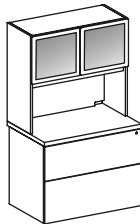

Glass Doors Aluminum Frames

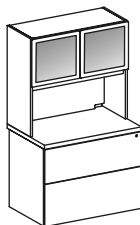

						Edge	Profile	Lower Pull		
S50-HLF-	30N	65	24	2LF-	GDW				253	2,589
S50-HLF-	30N	72	24	2LF-	GDW				263	2,604
S50-HLF-	36N	65	24	2LF-	GDW				265	2,695
S50-HLF-	36N	72	24	2LF-	GDW				275	2,712

Choose door frame finish from the current WoodPlus2 door finishes.

Door frame finish may be chosen from the current WoodPlus2 XTRA door finishes for List \$600 per order charge.

						Edge	Profile	Lower Pull		
S50-HLF-	30N	65	24	2LF-	GDA				0	2,589
S50-HLF-	30N	72	24	2LF-	GDA				0	2,604
S50-HLF-	36N	65	24	2LF-	GDA				0	2,695
S50-HLF-	36N	72	24	2LF-	GDA				0	2,712

Locks and Pulls are not available Glass Doors. Optional CLEAR glass doors . . .Add \$210 per unit.

Edge profiles:

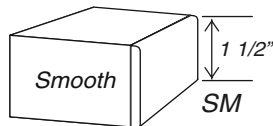

3mm WoodPlus PVC designation
3mm Standard hardwood edge

WPFS
SWFS

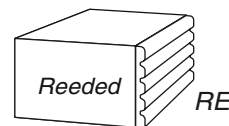

WPFR
SWFR

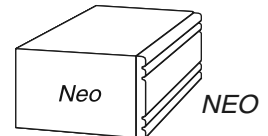

WPFN
SWFN

No pulls or locks available with glass doors.

30N Nominal width is 30". Actual width is 29.75". Does not support standard width hutch at 30".
36N Nominal width is 36". Actual width is 35.75". Does not support standard width hutch at 36".

The above Series 50 models with glass doors are NOT available on MAGNA NOW! - 10 day ship program

Series 50 Towers

Bookcases with finished back (matches case) and worksurface top

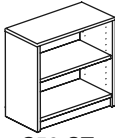

S50-ST
BCB-3029

	Wide	High	Deep	Edgez	Profile	Wt	WPE List
S50-ST-BCB-	30	29	15			77	734
S50-ST-BCB-	36	29	15			99	766

Includes worksurface top and one adjustable shelf.

IMPORTANT: Two rows of binders do not fit into 29 high bookcases.

Length of the top matches the width of the 30" wide bookcase at 29.75"

Length of the top matches the width of the 36" wide bookcase at 35.75"

Weight limit is 100 lbs per shelf.

Bottom fixed shelf is 14-1/16 deep.

All adjustable shelves are 13-15/16 deep

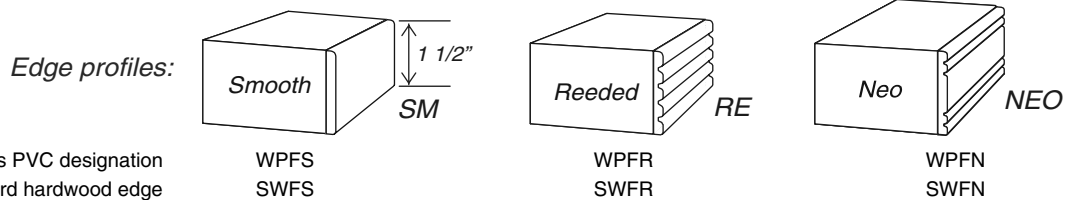

Bookcases with finished back (matches case)

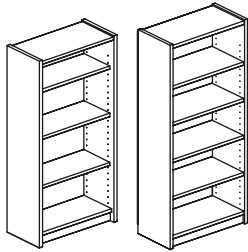

S50-ST-
BCB-3065

S50-ST-
BCB-3072

	Wide	High	Deep	Adjustable Shelves	Wt	WPE List
S50-ST-BCB-	30	36	15	1	100	715
S50-ST-BCB-	30	41	15	2	110	772
S50-ST-BCB-	30	48	15	2	134	772
S50-ST-BCB-	30	53	15	3	144	809
S50-ST-BCB-	30	60	15	3	169	839
S50-ST-BCB-	30	65	15	3	179	839
S50-ST-BCB-	30	72	15	4	185	881
S50-ST-BCB-	36	36	15	1	124	746
S50-ST-BCB-	36	41	15	2	134	803
S50-ST-BCB-	36	48	15	2	158	803
S50-ST-BCB-	36	53	15	3	168	841
S50-ST-BCB-	36	60	15	3	189	868
S50-ST-BCB-	36	65	15	3	199	868
S50-ST-BCB-	36	72	15	4	225	910

The width of the 30" wide bookcase at 29.75"

The width of the 36" wide bookcase at 35.75"

Weight limit is 100 lbs per shelf.

Bottom fixed shelf is 14-1/16 deep.

All adjustable shelves are 13-15/16 deep

Top for bookcases at 36, 41, 48, 53, 60, 65 and 72 high

	Wide	High	Edgez	Profile	Grain	Wt	WPE List
S50-TOP-CR-	15	30N			S2S	15	246
S50-TOP-CR-	15	36N			S2S	20	260

Length of the '30N' top matches the width of the 30" wide bookcase at 29.75"

Length of the '36N' top matches the width of the 36" wide bookcase at 35.75"

Additional shelves

ESH						15	57
-----	--	--	--	--	--	----	----

Please specify that the model number that the shelf will be used in.

All Series 50 models on this page - when ordered with WPE WoodPlus edge - are available on MAGNA NOW! - 10 day ship program

Series 50 accessories

Keyboard Trays

RKT-ME
with mouse extension

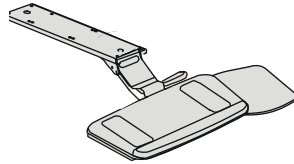

List Price **263**
11 deep, 30 long
Black molded tray

Grommet and Grommet Inserts

These grommet inserts fit into existing GRE or GRC grommets.

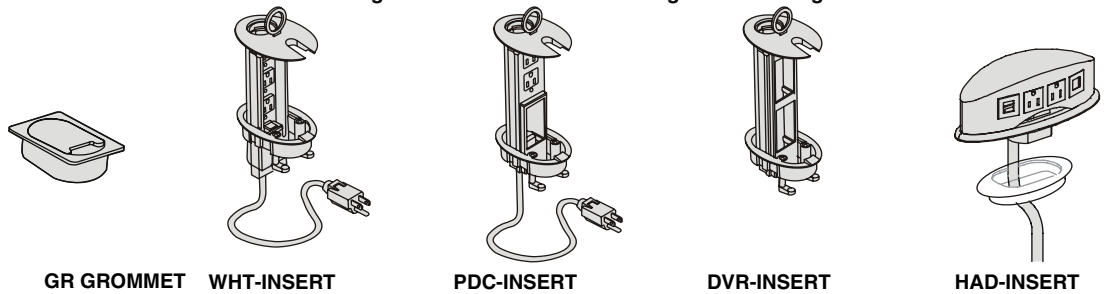

List Price **48**
Grommets are 2.75" x 4.25"
with an opening of 2" X 3.5"

148

138

66

177

Port Cutouts and Inserts

These interport and miniport inserts do NOT fit into Grommet cutouts.
These must be ordered when product is built.

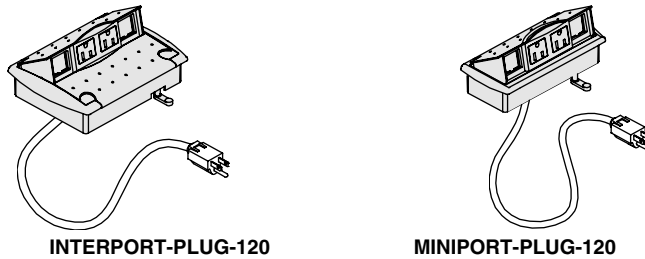

List Price **236**

197

Center Drawer

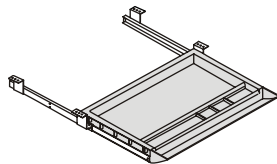

17 deep, 21 long
Black molded drawer

List Price **44**

All of the models on this page are available on MAGNA NOW! - 10 day ship program

Series 50 index

	page	
Accessories	35	
CDM-21 Center drawer	35	
Configurations	11 and 12	
DTO-..... Desk top organizer	25	
DVR-INSERT	35	
Finishes	7	
Top edge profiles	7	
FPI.... Tackboards for hutch	25	
FPW... Tackboards wall mounted	27	
GR grommets	35	
Grain direction - tops	9	
HAD-INSERT	35	
INTERPORT-PLUG	35	
Left or Right layouts	9	
MAGNA NOW! Ship program	7	
MINIPORT-PLUG	35	
Modesty Panels - shaped	10	
MPSC or MPSF	10	
Overheads wall mounted	26	
PDC-INSERT	35	
PSS Paper storage shelf for hutch	25	
Pulls - drawers	7	
Pulls - doors	23	
RKT... Keyboard trays	35	
Specifications	7	
S50-B.... Bridges	16	
S50-CE..... Corner extensions	15	
S50-CNR.... Corner units	15	
S50-CR-... Credenzas	20 and 21	
S50-D.... Desks	13 and 14	
S50-DE-... Desk extensions	19	
S50-FDT... Flipper door overhead	26	
S50-FPI... Tackboards for hutches	25	
S50-GDAT... Overhead with hinged glass doors, aluminum frame	26	
S50-GDWT... Overhead with hinged glass doors, WoodPlus2 frame	26	
S50-H-... OPEN Hutches open	25	
S50-H-... HD or HSD Hutches with WoodPlus doors	23	
S50-H-... GDW Hutches with WoodPlus frame glass doors	24	
S50-H-... GDA Hutches with Aluminum frame glass doors	24	
S50-HDT... Hinged door overhead	26	
S50-HLF.... Lateral file drawers with hutch above	33	
S50-R-.... Returns	17 and 18	
S50-ST-..LF.. Tower - 2, 3 or 4 LF drawers	32	
S50-ST...OPEN Tower with Open upper section	28	Lower section with drawers
S50-ST...OPEN Tower with Open upper section	30	Lower section with doors
S50-ST...UGDA Tower with Upper Glass Doors	29	Lower section with drawers
S50-ST...UGDA Tower with Upper Glass Doors	31	Lower section with doors
S50-ST...UGDW Tower with Upper Glass Doors	29	Lower section with drawers
S50-ST...UGDW Tower with Upper Glass Doors	31	Lower section with doors
S50-ST...UHD Tower with Upper Hinged Doors	28	Lower section with drawers
S50-ST...UHD Tower with Upper Hinged Doors	30	Lower section with doors
S50-ST-BCB.. Bookcase with worksurface top	34	
S50-ST-BCB.. Bookcases, various heights, inset top	34	
S50-TD-... Round tables	19	
Warranty	7	
WHT-INSERT	35	
WL... Tasklights	27	

Series 50 Tops

Top edge z	WPE, STD	Pricing is for WPE WoodPlus edge, upcharge for STD 3mm wood edge, per top	STD add	100
Edge profile	SM, RE, NEO	SM smooth profile, RE Reeded profile, NEO Neoclassic profile		

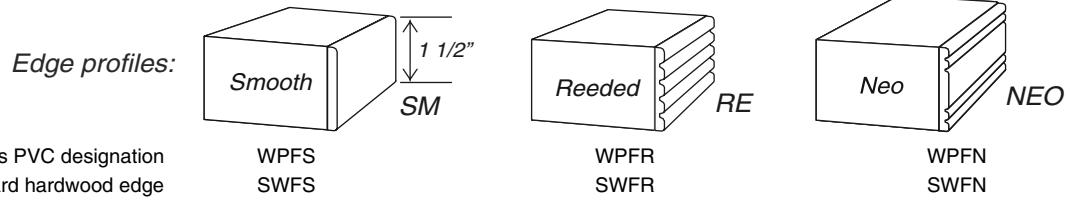

Tops

	Deep	Long	L / R	Grain	Edge z	Profile	Wt	List
S50-TOP-CR-	24	30		S2S			25	246
S50-TOP-CR-	24	36		S2S			30	260
S50-TOP-CR-	24	42		S2S			35	274
S50-TOP-CR-	24	48		S2S			40	274
S50-TOP-CR-	24	54		S2S			45	288
S50-TOP-CR-	24	60		S2S			50	303
S50-TOP-CR-	24	66		S2S			55	323
S50-TOP-CR-	24	72		S2S			60	343
S50-TOP-CR-	24	30		F2B			25	246
S50-TOP-CR-	24	36		F2B			30	260
S50-TOP-CR-	24	42		F2B			35	274
S50-TOP-CR-	24	48		F2B			40	274
S50-TOP-CR-	24	54		F2B			45	288
S50-TOP-CR-	24	60		F2B			50	303
S50-TOP-CR-	30	16		S2S			17	278
S50-TOP-CR-	30	30		S2S			32	319
S50-TOP-CR-	30	32		S2S			34	328
S50-TOP-CR-	30	36		S2S			37	339
S50-TOP-CR-	30	60		S2S			63	354
S50-TOP-CR-	30	66		S2S			69	374
S50-TOP-CR-	30	72		S2S			75	395
S50-TOP-CR-	36	66		S2S			83	420
S50-TOP-CR-	36	72		S2S			90	442
S50-TOP-BE-	30	60		S2S			63	602
S50-TOP-BE-	30	66		S2S			69	626
S50-TOP-BE-	30	72		S2S			75	644
S50-TOP-BOW-	36	60		S2S			75	631
S50-TOP-BOW-	36	66		S2S			83	661
S50-TOP-BOW-	36	72		S2S			90	691
S50-TOP-CE-	36	60	L	S2S			75	762
S50-TOP-CE-	36	60	R	S2S			75	762
S50-TOP-CE-	36	66	L	S2S			83	790
S50-TOP-CE-	36	66	R	S2S			83	790
S50-TOP-CE-	36	72	L	S2S			90	819
S50-TOP-CE-	36	72	R	S2S			90	819
S50-TOP-CF-	42	72	L	S2S			105	944
S50-TOP-CF-	42	72	R	S2S			105	944

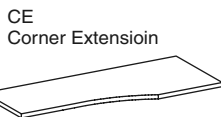
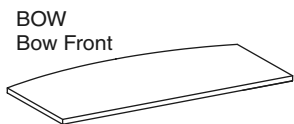
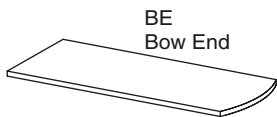
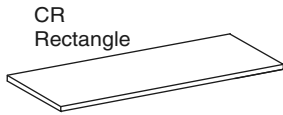

Right
shown

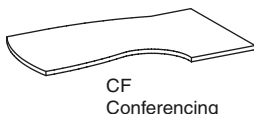

Right
shown

All of the Series 50 models on this page are available on MAGNA NOW! - 10 day ship program

Series 50 Tops

Top edge WPE, STD

Pricing is for WPE WoodPlus edge, upcharge for STD 3mm wood edge, per top

STD add 100

Edge prof SM. RE. NEO

SM smooth profile, RE Reeded profile, NEO Neoclassic profile

Edge profiles:

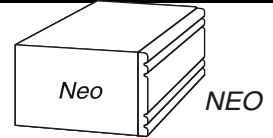
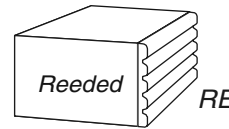
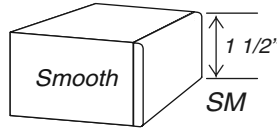

3mm WoodPlus PVC designation
3mm Standard hardwood edge

WPFS
SWFS

WPFR
SWFR

WPFN
SWFN

Tops

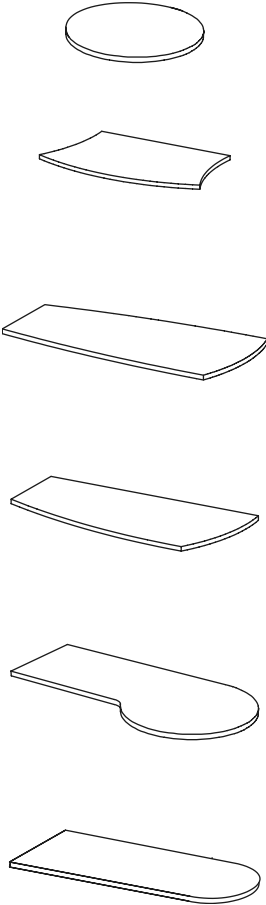

	Deep	Long	L / R	Grain	Edge z	Profile	Wt	List
S50-TOP-DIA-	36						45	587
S50-TOP-DIA-	42						58	645
S50-TOP-DIA-	48						70	694
S50-TOP-DIA-	54						83	835
S50-TOP-DIA-	58						95	924
S50-TOP-CAP-	48	36		F2B			60	774
S50-TOP-CAP-	60	36		F2B			75	832
S50-TOP-FAN-	36	60	L	S2S			75	762
S50-TOP-FAN-	36	60	R	S2S			75	762
S50-TOP-FAN-	36	66	L	S2S			83	790
S50-TOP-FAN-	36	66	R	S2S			83	790
S50-TOP-FAN-	36	72	L	S2S			90	819
S50-TOP-FAN-	36	72	R	S2S			90	819
S50-TOP-WE-	36	60	L	S2S			75	762
S50-TOP-WE-	36	60	R	S2S			75	762
S50-TOP-WE-	36	66	L	S2S			83	790
S50-TOP-WE-	36	66	R	S2S			83	790
S50-TOP-WE-	36	72	L	S2S			90	819
S50-TOP-WE-	36	72	R	S2S			90	819
S50-TOP-P-	42	60	L	S2S			75	829
S50-TOP-P-	42	60	R	S2S			75	829
S50-TOP-P-	42	66	L	S2S			83	841
S50-TOP-P-	42	66	R	S2S			83	841
S50-TOP-P-	42	72	L	S2S			90	888
S50-TOP-P-	42	72	R	S2S			90	888
S50-TOP-RE-	30	60		S2S			75	599
S50-TOP-RE-	30	66		S2S			83	646
S50-TOP-RE-	30	72		S2S			90	669

Legs

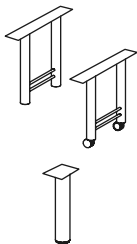

S50-HLEG-3DIA	246
S50-HLEG-3DIA-CA	289
S50-COLUMN	56

All of the Series 50 models on this page are available on MAGNA NOW! - 10 day ship program

Series 50 Lower cabinets and pedestals

Pull 10,12,13,14,15,18,19

Choose pull style for the pedestal drawers

Pedestals

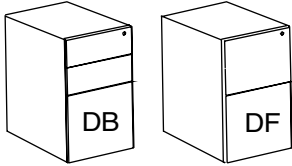

	Wide	Deep	LOCK	Pull			Wt	List
S50-PED-DB-	16	24	LOCK				82	780
S50-PED-DF-	16	24	LOCK				82	780
S50-PED-DSL-	16	24	LOCK				82	780
S50-PED-DSR-	16	24	LOCK				82	780
S50-PED-BDL-	16	24	LOCK				82	780
S50-PED-BDR-	16	24	LOCK				82	780

Lateral files

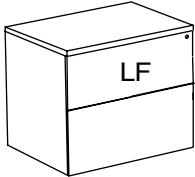

	Wide	Deep	LOCK	Pull			Wt	List
S50-CAB-LF-	30	24	LOCK				142	1,136
S50-CAB-LF-	36	24	LOCK				142	1,136
S50-CAB-LF-	36	30	LOCK				142	1,136
S50-CAB-LF-	36	30	LOCK				142	1,136

Combo cabinets

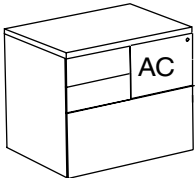

	Wide	Deep	LOCK	Pull			Wt	List
S50-CAB-AC-	32	24	LOCK				142	1,136
S50-CAB-AC-	32	30	LOCK				142	1,136
S50-CAB-BC-	32	24	LOCK				142	1,136
S50-CAB-BC-	32	30	LOCK				142	1,136

Door storage cabinets

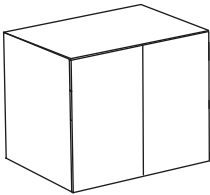

	Wide	Deep	Pull			Wt	List
S50-CAB-DS-	24	24				125	803
S50-CAB-DS-	28	24				125	803
S50-CAB-DS-	30	24				133	803
S50-CAB-DS-	34	24				133	803
S50-CAB-DS-	36	24				148	803
S50-CAB-DS-	40	24				148	803

Open storage cabinets

	Wide	Deep	Wt	List
S50-CAB-OS-	30	15	98	661
S50-CAB-OS-	36	15	98	661
S50-CAB-OS-	30	24	98	725
S50-CAB-OS-	36	24	98	793

End Panels for use with Modesty Panels

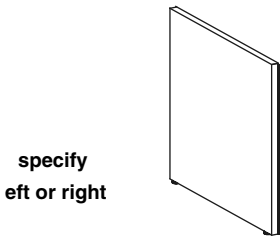

	Wide	L / R	Wt	List
S50-EP-	24	L	16	135
S50-EP-	24	R	16	135
S50-EP-	30	L	20	146
S50-EP-	30	R	20	146
S50-EP-	36	L	34	150
S50-EP-	36	R	34	150

End Panels with T End Panel included

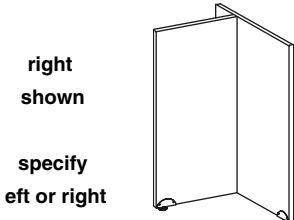

	Wide	L / R	Wt	List
S50-EPT-	24	L	24	215
S50-EPT-	24	R	24	215
S50-EPT-	30	L	28	227
S50-EPT-	30	R	28	227
S50-EPT-	36	L	32	236
S50-EPT-	36	R	32	236

All of the Series 50 models on this page are available on MAGNA NOW! - 10 day ship program